

Technical Data Sheet

Date: 03/11/2022

4x32A CEE N. Panel Mount Appliance Inlet (70x70)

Ref. No: 3126-319-1670



Pack Unit

10



Weight

149 gr.



Technical Informations





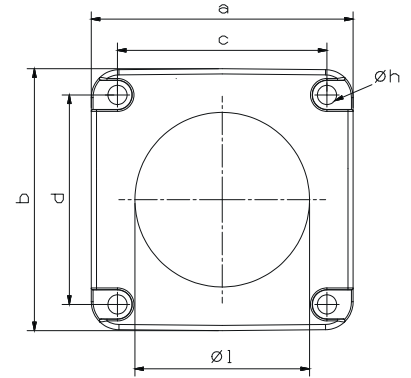
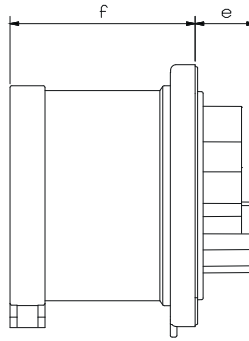

| | |
|------------------|----------------------------|
| Ampere | 32A |
| Voltage | 380 - 415 V. AC |
| Hertz | 50 - 60 Hz |
| Protection Class | IP 44 |
| Clock Postion | 6h |
| Number Of Poles | 4 (3P + E) |
| Contact Material | Brass (CuZn) |
| Housing Material | PA6 |
| Connection Type | Screw |
| Operation Temp. | -25 / +80 (1 hour -100° C) |
| | (-25 / + 40 IEC 60309) |

Dimensions

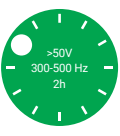
| | | | |
|-----------------------|---------------------|----|-----|
| a | 70 | e | 18 |
| b | 70 | f | 53 |
| c | 56 | Øh | 5,5 |
| d | 56 | Øl | 56 |
| Cable Diameter (Min.) | 2,5 mm ² | | |
| Cable Diameter (Max.) | 6 mm ² | | |

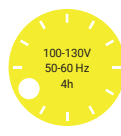

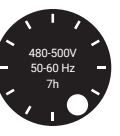
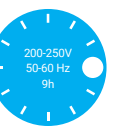
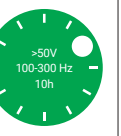
Different Earth Contact Positions (Clock Positions)

| | | | | | | | | |
|---|--|---|---|---|--|---|--|---|
|  -50V 300-500 Hz 2h |  380V-50 Hz 440V-60Hz 3h |  100-130V 50-60 Hz 4h |  600-690V 50-60 Hz 5h |  380-415V 50-60 Hz 6h |  480-500V 50-60 Hz 7h |  200-250V 50-60 Hz 9h |  -50V 100-300 Hz 10h |  440-460V 60 Hz 11h |
| 3126-319-1170-2h | 3126-319-1670-3h | 3126-319-0770-4h | 3126-319-0370-5h | 3126-319-1670 | 3126-319-0370-7h | 3126-319-0970-9h | 3126-319-1170-10h | 3126-319-1670-11h |



Tel: +90 232 880 90 01
Fax: +90 232 880 90 02



info@tpelectric.com.tr



Kemalpaşa O.S.B. 600 Sk. No:364
35730 Kemalpaşa - İZMİR / TÜRKİYE