

Technical Data Sheet

Date: 03/11/2022

4x32A CEE N. Surface Mount App. Inlet (With Cover)

Ref. No: 3126-313-1600



Pack Unit

5



Weight

250 gr.



Technical Informations





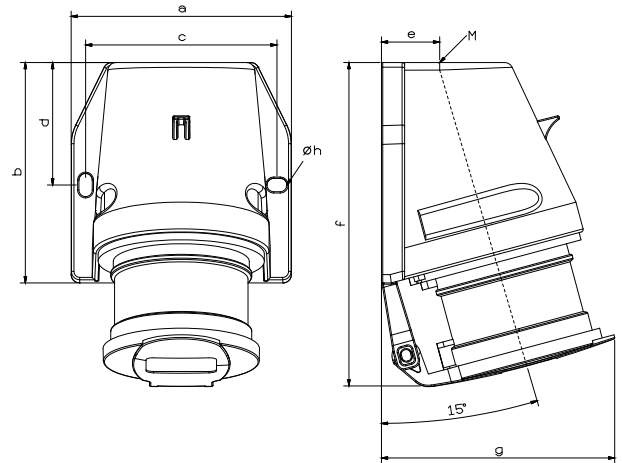

Ampere	32A
Voltage	380 - 415 V. AC
Hertz	50 - 60 Hz
Protection Class	IP 44
Clock Postion	6h
Number Of Poles	4 (3P + E)
Contact Material	Brass (CuZn)
Housing Material	PA6
Connection Type	Screw
Operation Temp.	-25 / +80 (1 hour -100° C)
	(-25 / + 40 IEC 60309)

Dimensions

a	88	e	22
b	88	f	137
c	76	g	95
d	48,5	Øh	5,3
Cable Diameter (Min.)	2,5 mm ²	M	M25x1,5
Cable Diameter (Max.)	10 mm ²		

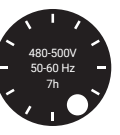
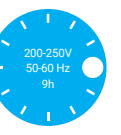
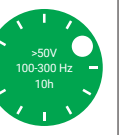

Different Earth Contact Positions (Clock Positions)

 -50V 300-500 Hz 2h	 380V-50 Hz 440V-60Hz 3h	 100-130V 50-60 Hz 4h	 600-690V 50-60 Hz 5h	 380-415V 50-60 Hz 6h	 480-500V 50-60 Hz 7h	 200-250V 50-60 Hz 9h	 -50V 100-300 Hz 10h	 440-460V 60 Hz 11h
3126-313-1100-2h	3126-313-1600-3h	3126-313-0700-4h	3126-313-0300-5h	3126-313-1600	3126-313-0300-7h	3126-313-0900-9h	3126-313-1100-10h	3126-313-1600-11h



Tel: +90 232 880 90 01
Fax: +90 232 880 90 02



info@tpelectric.com.tr



Kemalpaşa O.S.B. 600 Sk. No:364
35730 Kemalpaşa - İZMİR / TÜRKİYE