

Technical Data Sheet

Date: 03/11/2022

4x16A CEE N. Panel Mount Appliance Inlet (70x70)

Ref. No: 3122-319-1670



Pack Unit

10



Weight

110 gr.



Technical Informations





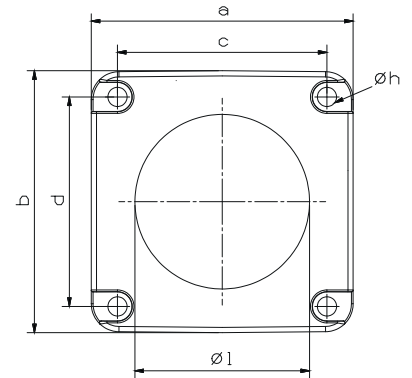
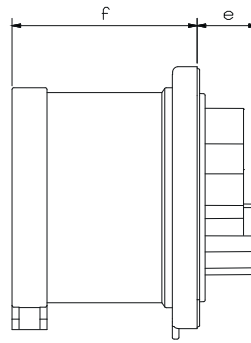

Ampere	16A
Voltage	380 - 415 V. AC
Hertz	50 - 60 Hz
Protection Class	IP 44
Clock Postion	6h
Number Of Poles	4 (3P + E)
Contact Material	Brass (CuZn)
Housing Material	PA6
Connection Type	Screw
Operation Temp. (-25 / + 40 IEC 60309)	-25 / +80 (1 hour -100° C)

Dimensions

a	70	e	18
b	70	f	44
c	56	Øh	5,5
d	56	Øl	52
Cable Diameter (Min.)	1 mm ²		
Cable Diameter (Max.)	2,5 mm ²		

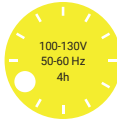

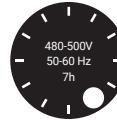
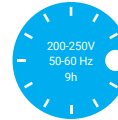
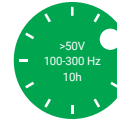
Different Earth Contact Positions (Clock Positions)

 -50V 300-500 Hz 2h	 380V-50 Hz 440V-60Hz 3h	 100-130V 50-60 Hz 4h	 600-690V 50-60 Hz 5h	 380-415V 50-60 Hz 6h	 480-500V 50-60 Hz 7h	 200-250V 50-60 Hz 9h	 -50V 100-300 Hz 10h	 440-460V 60 Hz 11h
3122-319-1170-2h	3122-319-1670-3h	3122-319-0770-4h	3122-319-0370-5h	3122-319-1670	3122-319-0370-7h	3122-319-0970-9h	3122-319-1170-10h	3122-319-1670-11h



Tel: +90 232 880 90 01
Fax: +90 232 880 90 02



info@tpelectric.com.tr



Kemalpaşa O.S.B. 600 Sk. No:364
35730 Kemalpaşa - İZMİR / TÜRKİYE