

Technical Data Sheet

Date: 03/11/2022

4x16A CEE Norm Connector

Ref. No: 3122-304-1601



Pack Unit

10



Weight

166 gr.



Technical Informations



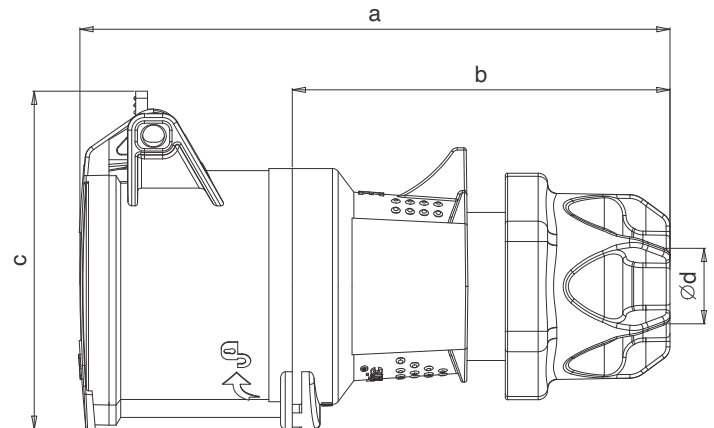

Ampere	16A
Voltage	380 - 415 V. AC
Hertz	50 - 60 Hz
Protection Class	IP 44
Clock Position	6h
Number Of Poles	4 (3P + E)
Contact Material	Brass (CuZn)
Housing Material	PA6
Connection Type	Screw
Operation Temp.	-25 / +80 (1 hour -100° C)
	(-25 / + 40 IEC 60309)

Dimensions

a	135
b	89
c	78
Ød	6-16
Cable Diameter (Min.)	1 mm ²
Cable Diameter (Max.)	2,5 mm ²

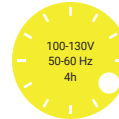

Different Earth Contact Positions (Clock Positions)

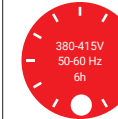
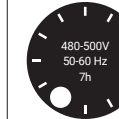
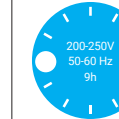
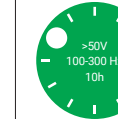
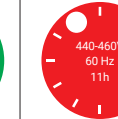
 -50V 300-500 Hz 2h	 380V-50 Hz 440V-60Hz 3h	 100-130V 50-60 Hz 4h	 600-690V 50-60 Hz 5h	 380-415V 50-60 Hz 6h	 480-500V 50-60 Hz 7h	 200-250V 50-60 Hz 9h	 -50V 100-300 Hz 10h	 440-460V 60 Hz 11h
3122-304-1101-2h	3122-304-1601-3h	3122-304-0701-4h	3122-304-0301-5h	3122-304-1601	3122-304-0301-7h	3122-304-0901-9h	3122-304-1101-10h	3122-304-1601-11h



Tel: +90 232 880 90 01
Fax: +90 232 880 90 02



info@tpelectric.com.tr



Kemalpaşa O.S.B. 600 Sk. No:364
35730 Kemalpaşa - İZMİR / TÜRKİYE