

Technical Data Sheet

Date: 03/11/2022

3x16A CEE N. Panel Mount Socket Outlet

Ref. No: 3020-321-0970



Pack Unit

10



Weight

106 gr.



Technical Informations

Quick Connection

Ampere	16A
Voltage	200 - 250 V. AC
Hertz	50 - 60 Hz
Protection Class	IP 44
Clock Position	6h
Number Of Poles	3 (2P + E)
Contact Material	Brass (CuZn)
Housing Material	PA6
Connection Type	Quick
Operation Temp.	-25 / +80 (1 hour -100° C)
	(-25 / + 40 IEC 60309)

Dimensions

a	70	e	24
b	70	f	49
c	56	g	95
d	56	Øh	5,5
Cable Dia. (Flex. Min.)	1 mm ²	Øl	44
Cable Dia. (Flex. Max.)	2,5 mm ²	k	86
Cable Dia. (Rigid Min.)	1 mm ²		
Cable Dia. (Rigid Max.)	4 mm ²		

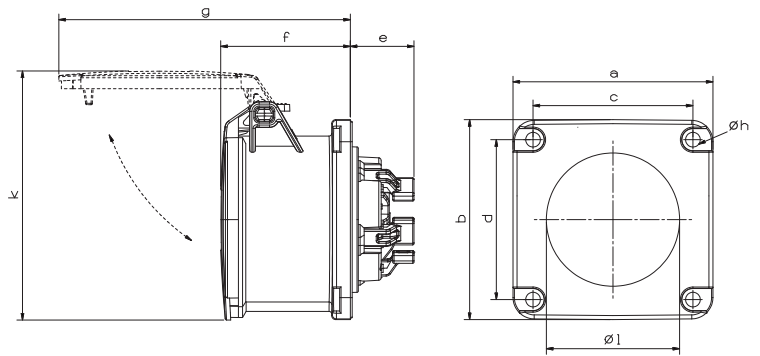

Different Earth Contact Positions (Clock Positions)

 >50V 300-500 Hz 2h 3020-321-1170-2h	 100-130V 50-60 Hz 4h 3020-321-0770-4h	 200-250V 50-60 Hz 6h 3020-321-0970	 480-500V 50-60 Hz 7h 3020-321-0370-7h	 380-415V 50-60 Hz 9h 3020-321-1670-9h
--	--	---	--	--



Tel: +90 232 880 90 01
Fax: +90 232 880 90 02



info@tpelectric.com.tr



Kemalpaşa O.S.B. 600 Sk. No:364
35730 Kemalpaşa - İZMİR / TÜRKİYE