

Technical Data Sheet

Date: 04/26/2022

1x16A Rubber Connector

Ref. No: 3101-325-0300



Pack Unit

24



Weight

91 gr.



Child
Protection

Technical Informations

Version	French
Ampere	16A
Voltage	250 V. AC
Protection Class	IP 54
Number Of Poles	3 (2P + E)
Contact Material	MS 58
Contact Carrier	Polycarbonate
Plastic Material	Thermoplastic Elastomer
Connection Type	Screw
Operation Temperature	-15 / +70 (±2)



Compliance with European
Union 2011/65 /EU RoSH Directives



TS IEC 60884-1 / TS 40
NATIONAL

Dimensions

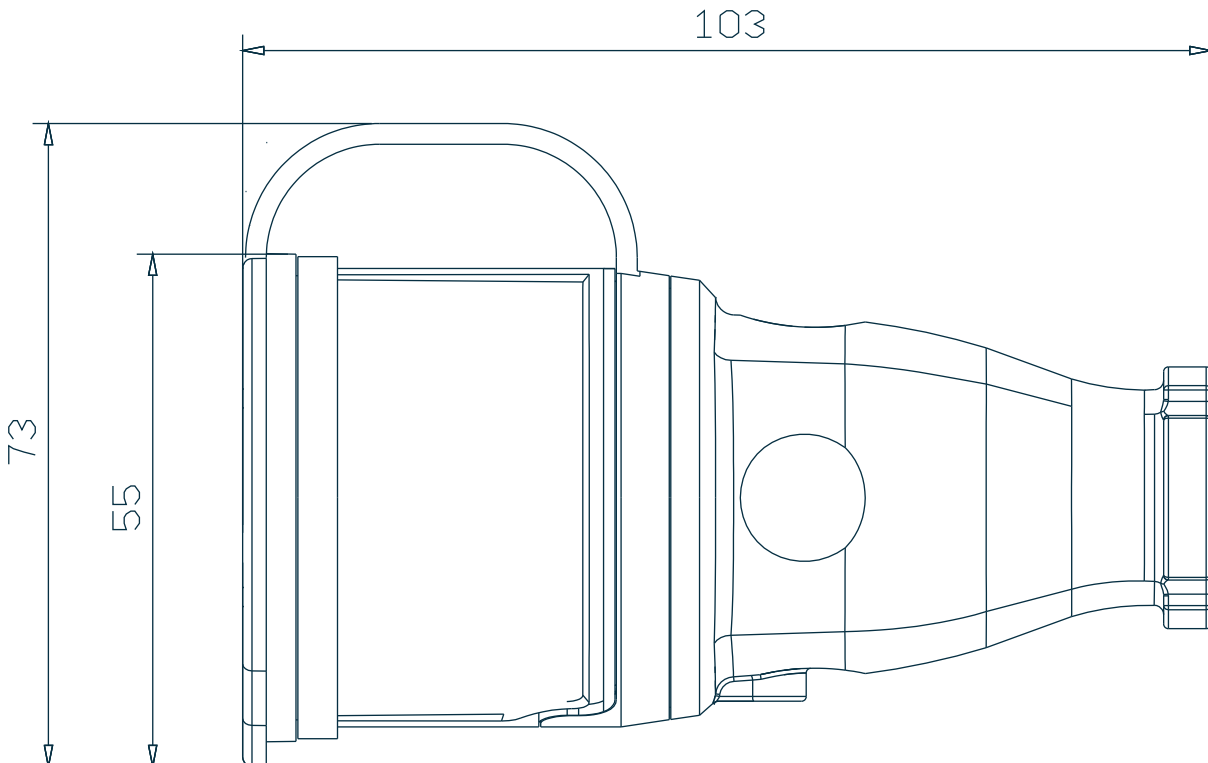

Tel: +90 232 880 90 01
Fax: +90 232 880 90 02



info@tpelectric.com.tr



Kemalpaşa O.S.B. 600 Sk. No:364
35730 Kemalpaşa - İZMİR / TÜRKİYE