

Technical Data Sheet

Date: 04/26/2022

1x16A Rubber Angled Plug

Ref. No: 3101-302-0900



Pack Unit

40



Weight

69 gr.



Technical Informations

Version	German (DIN)
Ampere	16A
Voltage	250 V. AC
Protection Class	IP 44
Number Of Poles	3 (2P + E)
Contact Material	Nickle Plated
Contact Carrier	PC
Plastic Material	Thermoplastic Elastomer
Connection Type	Screw
Operation Temperature	-15 / +70 (±2)



Compliance with European Union 2011/65 /EU RoSH Directives



TS IEC 60884-1 / TS 40 NATIONAL

Dimensions

a	100
b	81
c	42
d	53

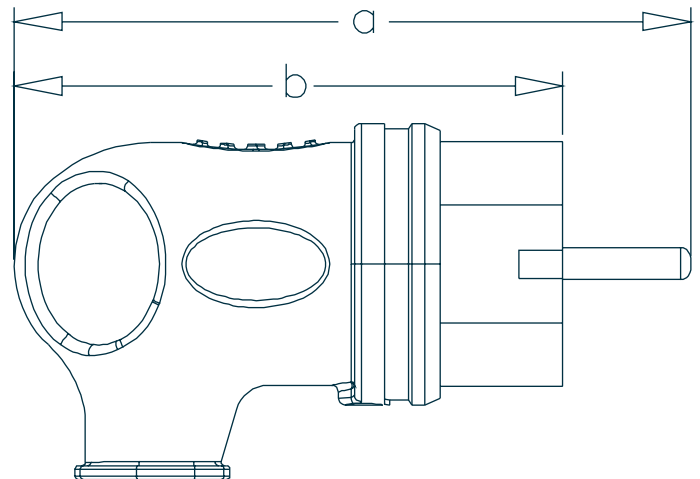
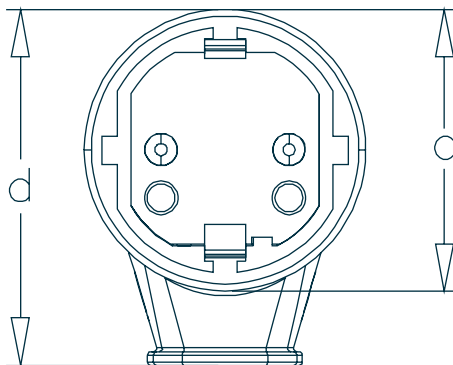

Tel: +90 232 880 90 01
Fax: +90 232 880 90 02



info@tpelectric.com.tr



Kemalpaşa O.S.B. 600 Sk. No:364
35730 Kemalpaşa - İZMİR / TÜRKİYE