





IEC 60884-1

Ev ve benzeri yerlerde kullanılan fiş ve prizler – Bölüm 1: Genel gereklilikler

Plugs and socket-outlets for household and similar purposes – Part 1: General requirements



1x16A Fiş ve Prizler

1x16A Plugs and Sockets

Fiş ve Priz Tipleri Plugs And Socket Types	30-31
1x16A Kauçuk Fiş ve Uzatma Prizleri Rubber Plugs And Connectors	32-33
1x16A Pro Serisi Rakorlu Fiş ve Uzatma Prizleri Pro Series Plugs And Connectors With Cable Gland	34-35
1x16 Pro Serisi Polyamid Üçlü ve Dörtlü Grup Prizler 1x16 Pro Series Polyamide 3-Way and 4-Way Group Sockets	36
Kauçuk Grup Prizler Rubber Group Sockets	37
Üç Yönlü Grup Prizler 3-Way Group Sockets	38
1x16A Kauçuk Duvar Prizleri Rubber Wall Socket	39
Seyyar Uygulamalar İçin Pano Prizi Panel Socket For Portable Applications	40
Pano Prizleri Socket Outlets	41-43
Duvar Tipi Pano Prizleri Wall Mount Socket Outlets	44-45
Makine Prizleri 75x75 Panel Mount Socket Outlets	46-47
Raya Montaj Prizler DIN Rail Mount Sockets	48
İnce Fişler Slim Plugs	49
Seyyar El Lambaları Portable Hand Lamps	50
IP68 Fiş Prizler IP68 Plugs And Sockets	51-53
Nemliyer Anahtar ve Prizler Weather Proof Products	54-67



FIŞ VE PRİZ TIPLERİ

PLUGS AND SOCKET TYPES

A TIPI / A TYPE

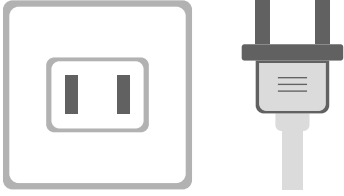

B TIPI / B TYPE

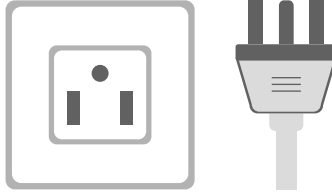

C TIPI / C TYPE

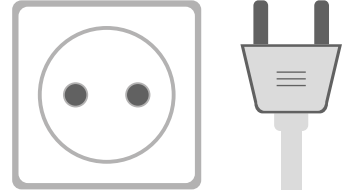

D TIPI / D TYPE

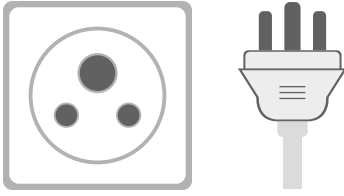

E TIPI / E TYPE

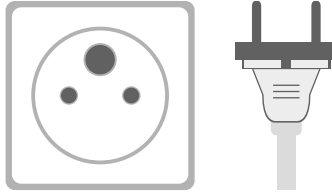

F TIPI / F TYPE

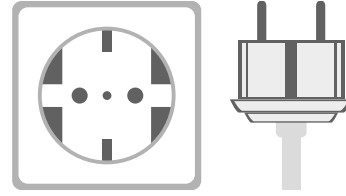

G TIPI / G TYPE

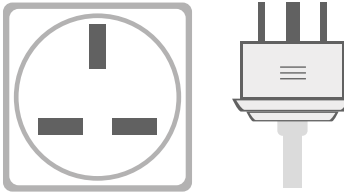

H TIPI / H TYPE

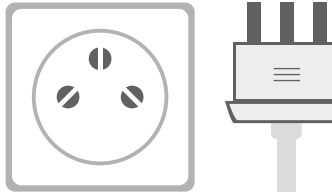

I TIPI / I TYPE

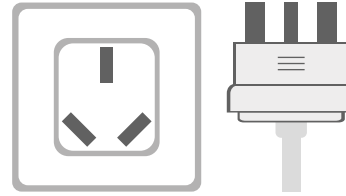

J TIPI / J TYPE

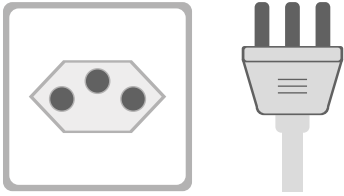

K TIPI / K TYPE

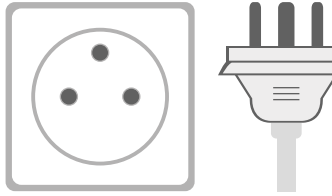

L TIPI / L TYPE

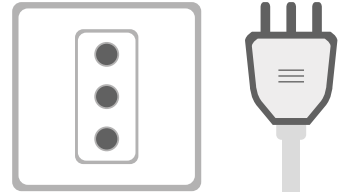

M TIPI / M TYPE

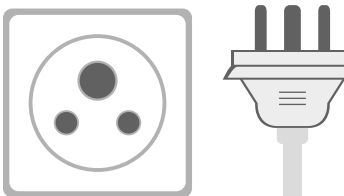

N TIPI / N TYPE

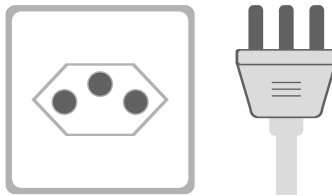

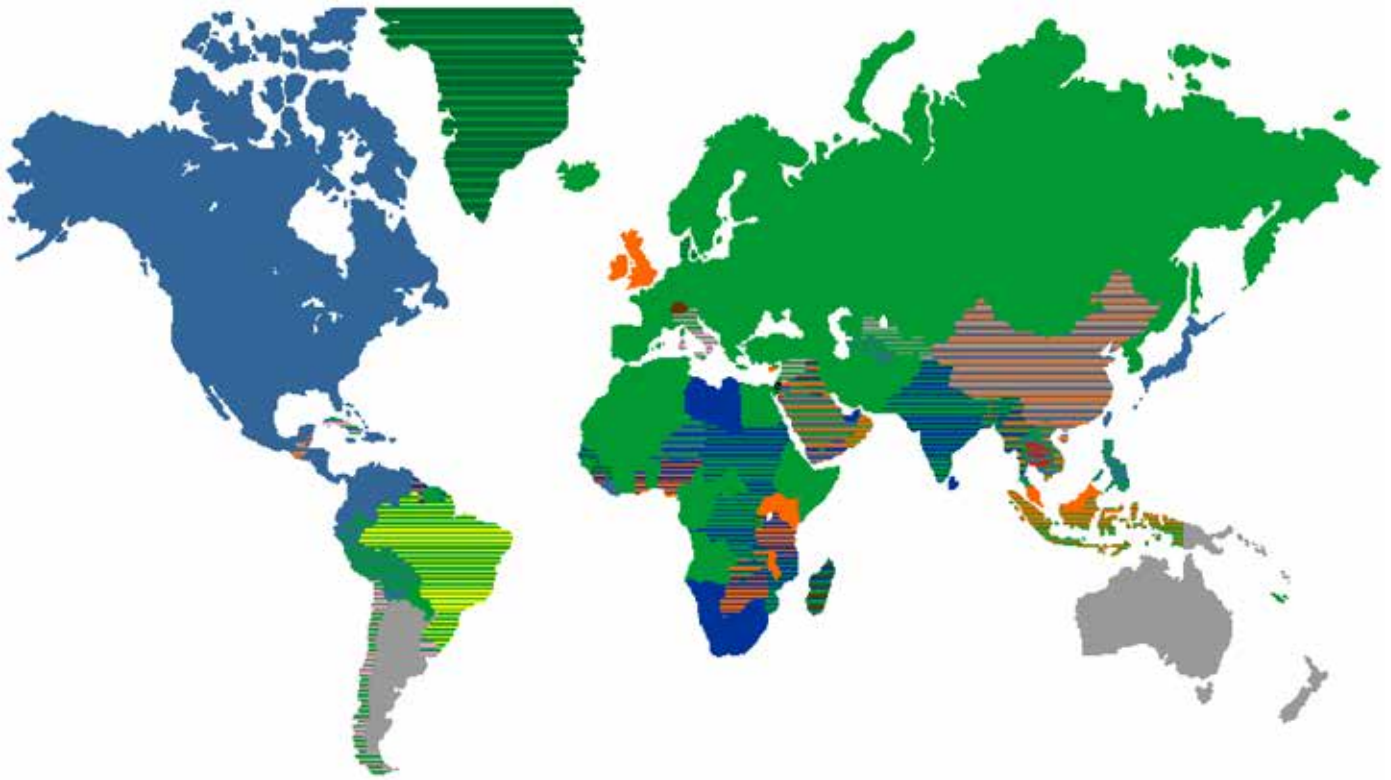

 A / B

 C / E / F

 D / M

 G

 H

 I

 J

 K

 L

 N

1x16A KAÜÇUK DÜZ VE EĐİK FİŞLER

1x16 RUBBER STRAIGHT AND ANGLED PLUGS

Düz Fiş Plug

IP44



Vidalı Bağlantı
Screw Connection

Kontakt-Amper Poles-Ampere	1x16A
Norm Version	Alman German (DIN) 
Voltaj Voltage	250V AC
Kontakt Malz. Contact Mat.	MS 58 + MS 70 (Toprak) MS 58 + MS 70 (Earth)
Kontakt Taşıma Gövdesi Contact Carrier	Polikarbonat Polycarbonate
Plastik Malzeme Plastic Material	Termoplastik Elastomer Thermoplastic Elastomer
Çalışma Sıcaklığı Operation Temperature	-15 / +70 (±2)
Kutu Adedi Pack. Unit	40
Ağırlık Weight	61 Gr.

Ürün Kodu Cat. No

3101-301-0700

3101-301-0900

3101-301-1600

3101-301-2300

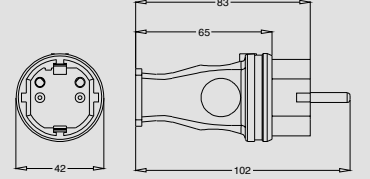

Eđik Fiş Angled Plug

IP44



Vidalı Bağlantı
Screw Connection

Kontakt-Amper Poles-Ampere	1x16A
Norm Version	Alman German (DIN) 
Voltaj Voltage	250V AC
Kontakt Malz. Contact Mat.	MS 58 + MS 70 (Toprak) MS 58 + MS 70 (Earth)
Kontakt Taşıma Gövdesi Contact Carrier	Polikarbonat Polycarbonate
Plastik Malzeme Plastic Material	Termoplastik Elastomer Thermoplastic Elastomer
Çalışma Sıcaklığı Operation Temperature	-15 / +70 (±2)
Kutu Adedi Pack. Unit	40
Ağırlık Weight	69 Gr.

Ürün Kodu Cat. No

3101-302-0700

3101-302-0900

3101-302-1600

3101-302-2300

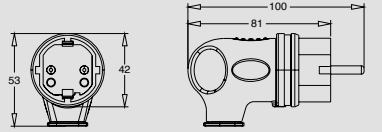

Düz Fiş Plug

IP44



Vidalı Bağlantı
Screw Connection

Kontakt-Amper Poles-Ampere	1x16A
Norm Version	Fransız French 
Voltaj Voltage	250V AC
Kontakt Malz. Contact Mat.	MS 58 + MS 70 (Toprak) MS 58 + MS 70 (Earth)
Kontakt Taşıma Gövdesi Contact Carrier	Polikarbonat Polycarbonate
Plastik Malzeme Plastic Material	Termoplastik Elastomer Thermoplastic Elastomer
Çalışma Sıcaklığı Operation Temperature	-15 / +70 (±2)
Kutu Adedi Pack. Unit	40
Ağırlık Weight	61 Gr.

Ürün Kodu Cat. No

3101-303-0700

3101-303-0900

3101-303-1600

3101-303-2300

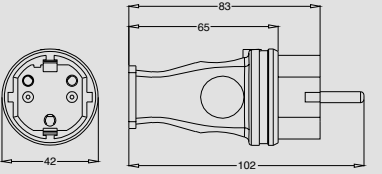

Eđik Fiş Angled Plug

IP44



Vidalı Bağlantı
Screw Connection

Kontakt-Amper Poles-Ampere	1x16A
Norm Version	Fransız French 
Voltaj Voltage	250V AC
Kontakt Malz. Contact Mat.	MS 58 + MS 70 (Toprak) MS 58 + MS 70 (Earth)
Kontakt Taşıma Gövdesi Contact Carrier	Polikarbonat Polycarbonate
Plastik Malzeme Plastic Material	Termoplastik Elastomer Thermoplastic Elastomer
Çalışma Sıcaklığı Operation Temperature	-15 / +70 (±2)
Kutu Adedi Pack. Unit	40
Ağırlık Weight	69 Gr.

Ürün Kodu Cat. No

3101-305-0700

3101-305-0900

3101-305-1600

3101-305-2300

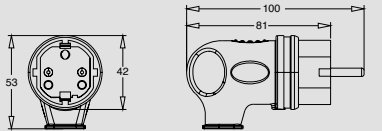

1x16A KAUÇUK UZATMA PRİZLERİ

1x16A RUBBER CONNECTORS

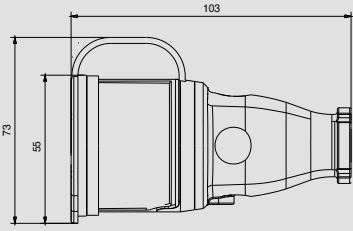

Ürün Kodu
Cat. No

	3101-304-0700
	3101-304-0900
	3101-304-1600
	3101-304-2300

Kontakt-Amper Poles-Ampere	1x16A
Norm Version	Alman German (DIN)
Voltaj Voltage	250V AC
Kontakt Malz. Contact Mat.	MS 70
Kontakt Taşıma Gövdesi Contact Carrier	Polikarbonat Polycarbonate
Plastik Malzeme Plastic Material	Termoplastik Elastomer Thermoplastic Elastomer
Çalışma Sıcaklığı Operation Temperature	-15 / +70 (±2)
Kutu Adedi Pack. Unit	24
Ağırlık Weight	91 Gr.

Uzatma Prizi (Geçmeli Kapak)
Connector (Press Lid)

IP54



Vidalı Bağlantı
Screw Connection

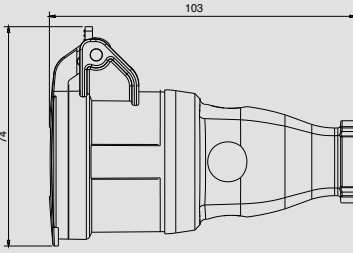

Ürün Kodu
Cat. No

	3101-394-0700
	3101-394-0900
	3101-394-1600
	3101-394-2300

Kontakt-Amper Poles-Ampere	1x16A
Norm Version	Alman German (DIN)
Voltaj Voltage	250V AC
Kontakt Malz. Contact Mat.	MS 70
Kontakt Taşıma Gövdesi Contact Carrier	Polikarbonat Polycarbonate
Plastik Malzeme Plastic Material	Termoplastik Elastomer Thermoplastic Elastomer
Çalışma Sıcaklığı Operation Temperature	-15 / +70 (±2)
Kutu Adedi Pack. Unit	24
Ağırlık Weight	91 Gr.

Uzatma Prizi (Yaylı Kapak)
Connector (Screw Lid)

IP54



Vidalı Bağlantı
Screw Connection

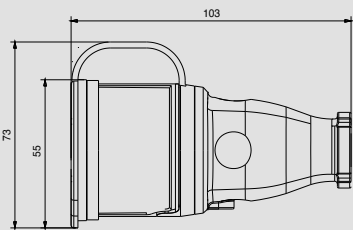

Ürün Kodu
Cat. No

	3101-325-0700
	3101-325-0900
	3101-325-1600
	3101-325-2300

Kontakt-Amper Poles-Ampere	1x16A
Norm Version	Fransız French
Voltaj Voltage	250V AC
Kontakt Malz. Contact Mat.	MS 70
Kontakt Taşıma Gövdesi Contact Carrier	Polikarbonat Polycarbonate
Plastik Malzeme Plastic Material	Termoplastik Elastomer Thermoplastic Elastomer
Çalışma Sıcaklığı Operation Temperature	-15 / +70 (±2)
Kutu Adedi Pack. Unit	24
Ağırlık Weight	91 Gr.

Uzatma Prizi (Geçmeli Kapak)
Connector (Press Lid)

IP54



Vidalı Bağlantı
Screw Connection

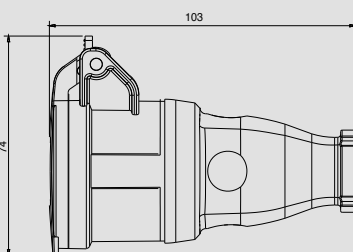

Ürün Kodu
Cat. No

	3101-395-0700
	3101-395-0900
	3101-395-1600
	3101-395-2300

Kontakt-Amper Poles-Ampere	1x16A
Norm Version	Fransız French
Voltaj Voltage	250V AC
Kontakt Malz. Contact Mat.	MS 70
Kontakt Taşıma Gövdesi Contact Carrier	Polikarbonat Polycarbonate
Plastik Malzeme Plastic Material	Termoplastik Elastomer Thermoplastic Elastomer
Çalışma Sıcaklığı Operation Temperature	-15 / +70 (±2)
Kutu Adedi Pack. Unit	24
Ağırlık Weight	91 Gr.

Uzatma Prizi (Yaylı Kapak)
Connector (Screw Lid)

IP54



Vidalı Bağlantı
Screw Connection

1x16A PRO SERİSİ RAKORLU DÜZ FİŞLER

1x16A PRO SERIES PLUG WITH CABLE GLAND

Rakorlu Düz Fiş Plug With Cable Gland

IP44



Vidalı Bağlantı
Screw Connection

Kontak-Amper Poles-Ampere	1x16A
Norm Version	Alman German (DIN)
Voltaj Voltage	250V AC
Kontak Malz. Contact Mat.	MS 58 + Nikel Kaplama + MS 70 (Toprak) MS 58 + Nickel Plated + MS 70 (Earth)
Kontak Taşıma Gövdesi Contact Carrier	Polikarbonat Polycarbonate
Plastik Malzeme Plastic Material	Polyamid (PA-6) Polyamide (PA-6)
Çalışma Sıcaklığı Operation Temperature	-15 / +70 (±2)
Kutu Adedi Pack. Unit	40
Ağırlık Weight	59 Gr.

Ürün Kodu
Cat. No

3101-700-1600



3101-700-0600



3101-700-0900



3101-700-0300

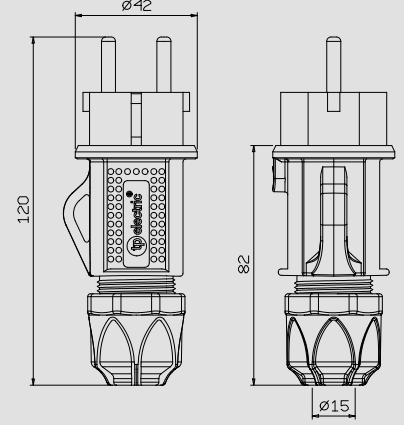

Rakorlu Düz Fiş (UPS) Plug With Cable Gland (UPS)

IP44



Vidalı Bağlantı
Screw Connection

Kontak-Amper Poles-Ampere	1x16A
Norm Version	Fransız French
Voltaj Voltage	250V AC
Kontak Malz. Contact Mat.	MS 58 + Nikel Kaplama + MS 70 (Toprak) MS58 + Nickel Plated + MS 70 (Earth)
Kontak Taşıma Gövdesi Contact Carrier	Polikarbonat Polycarbonate
Plastik Malzeme Plastic Material	Polyamid (PA-6) Polyamide (PA-6)
Çalışma Sıcaklığı Operation Temperature	-15 / +70 (±2)
Kutu Adedi Pack. Unit	40
Ağırlık Weight	60 Gr.

Ürün Kodu
Cat. No

3101-701-1600



3101-701-0600



3101-701-0900



3101-701-0300

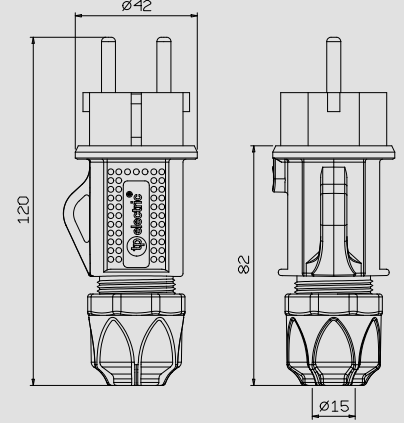

1x16A PRO SERİSİ RAKORLU UZATMA PRİZLER

1x16A PRO SERIES CONNECTOR WITH CABLE GLAND

Ürün Kodu Cat. No	3101-705-1600
	3101-705-0600
	3101-705-0900
	3101-705-0300

Kontak-Amper Poles-Ampere	1x16A
Norm Version	Alman German (DIN)
Voltaj Voltage	250V AC
Kontak Malz. Contact Mat.	Nikel Kaplama + MS 70 Nickel Plated + MS 70
Kontak Taşıma Gövdəsi Contact Carrier	Polikarbonat Polycarbonate
Plastik Malzeme Plastic Material	Polyamid (PA-6) Polyamide (PA-6)
Çalışma Sıcaklığı Operation Temperature	-15 / +70 (±2)
Kutu Adedi Pack. Unit	24
Ağırlık Weight	76 Gr.

Rakorlu Uzatma Prizi
Connector With Cable Gland

IP54

Vidalı Bağlantı
Screw Connection

Ürün Kodu Cat. No	3101-708-1600
	3101-708-0600
	3101-708-0900
	3101-708-0300

Kontak-Amper Poles-Ampere	1x16A
Norm Version	Fransız French
Voltaj Voltage	250V AC
Kontak Malz. Contact Mat.	Nikel Kaplama + MS 70 Nickel Plated + MS 70
Kontak Taşıma Gövdəsi Contact Carrier	Polikarbonat Polycarbonate
Plastik Malzeme Plastic Material	Polyamid (PA-6) Polyamide (PA-6)
Çalışma Sıcaklığı Operation Temperature	-15 / +70 (±2)
Kutu Adedi Pack. Unit	24
Ağırlık Weight	77 Gr.

Rakorlu Uzatma Prizi
Connector With Cable Gland

IP54

Vidalı Bağlantı
Screw Connection



1x16 PRO SERİSİ POLYAMİD ÜÇLÜ VE DÖRTLÜ GRUP PRİZLER

1x16 PRO SERIES POLYAMIDE 3-WAY AND 4-WAY GROUP SOCKETS

Üçlü Grup Priz

Three Way Socket Outlet

IP44



Vidalı Bağlantı
Screw Connection

Kontakt-Amper Poles-Ampere	1x16A
Norm Version	Alman German (DIN) 
Voltaj Voltage	220-250V AC
Kontakt Malz. Contact Mat.	MS 70
Kontakt Taşıma Gövdesi Contact Carrier	Polikarbonat (PC) Polycarbonate (PC)
Plastik Malzeme Plastic Material	Polyamid (PA-6) Polyamide (PA-6)
Çalışma Sıcaklığı Operation Temperature	-15 / +70 (±2)
Maksimum Güç Maximum Power	4000 W
Kutu Adedi Pack. Unit	9
Ağırlık Weight	4320 Gr.

Ürün Kodu
Cat. No

3101-630-0600



3101-630-0300

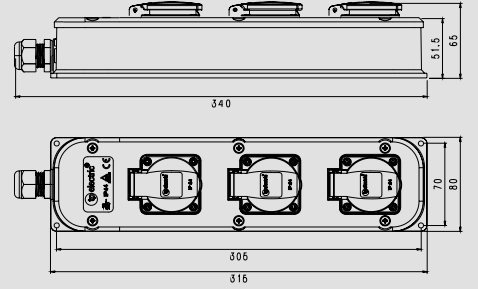

Dörtlü Grup Priz

Four Way Socket Outlet

IP44



Vidalı Bağlantı
Screw Connection

Kontakt-Amper Poles-Ampere	1x16A
Norm Version	Alman German (DIN) 
Voltaj Voltage	220-250V AC
Kontakt Malz. Contact Mat.	MS 70
Kontakt Taşıma Gövdesi Contact Carrier	Polikarbonat (PC) Polycarbonate (PC)
Plastik Malzeme Plastic Material	Polyamid (PA-6) Polyamide (PA-6)
Çalışma Sıcaklığı Operation Temperature	-15 / +70 (±2)
Maksimum Güç Maximum Power	4000 W
Kutu Adedi Pack. Unit	9
Ağırlık Weight	5000 Gr.

Ürün Kodu
Cat. No

3101-640-0600



3101-640-0300

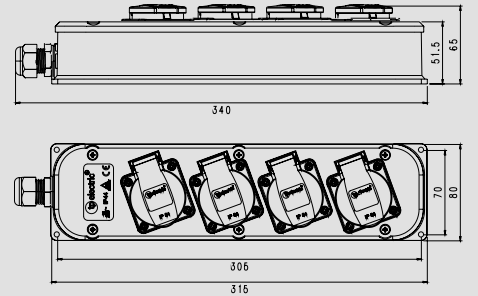

KAUÇUK GRUP PRİZLER

RUBBER GROUP SOCKETS



Çocuk Korumalı
Child Protection

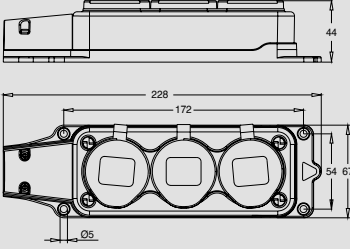

Ürün Kodu
Cat. No

3101-308-0300



3101-308-0700



3101-308-0900



3101-308-1600



3101-308-2300

Kontakt-Amper
Poles-Ampere

1x16A

Norm

Version

Alman

German (DIN)



Voltaj

Voltage

250V AC

Kontakt Malz.

Contact Mat.

MS 70

Kontakt Taşıma Gövdesi

Contact Carrier

Polikarbonat

Polycarbonate

Plastik Malzeme

Plastic Material

Termoplastik Elastomer

Thermoplastic Elastomer

Çalışma Sıcaklığı

Operation Temperature

-15 / +70 (±2)

Kutu Adedi

Pack. Unit

10

Ağırlık

Weight

213 Gr.

Grup Priz

Group Socket Outlet

IP44



Vidalı Bağlantı

Screw Connection



Çocuk Korumalı
Child Protection

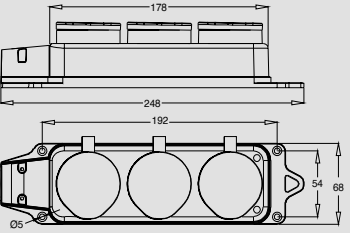

Ürün Kodu
Cat. No

3101-328-0300



3101-328-0700



3101-328-0900



3101-328-1600



3101-328-2300

Kontakt-Amper
Poles-Ampere

1x16A

Norm

Version

Fransız

French



Voltaj

Voltage

250V AC

Kontakt Malz.

Contact Mat.

MS 70

Kontakt Taşıma Gövdesi

Contact Carrier

Polikarbonat

Polycarbonate

Plastik Malzeme

Plastic Material

Termoplastik Elastomer

Thermoplastic Elastomer

Çalışma Sıcaklığı

Operation Temperature

-15 / +70 (±2)

Kutu Adedi

Pack. Unit

10

Ağırlık

Weight

287 Gr.

Grup Priz

Group Socket Outlet

IP44



Vidalı Bağlantı

Screw Connection

ÜÇ YÖNLÜ GRUP PRİZLER 3-WAY GROUP SOCKETS

Üç Yönlü Grup Priz (Geçmeli Kapak) 3-Way Group Socket (Press Lid)

IP54



Vidalı Bağlantı
Screw Connection

Kontakt-Amper Poles-Ampere	1x16A	Norm Version	Alman German	Ürün Kodu Cat. No	3101-314-0300
Faz Phase	Monofaze Mono Phase	Fransız French		3101-316-0300	
Voltaj Voltage	250V AC	Kontakt Malz. Contact Mat.	MS 70		
Kontakt Taşıma Gövdesi Contact Carrier	Polikarbonat Polycarbonate	Plastik Malzeme Plastic Material	Termoplastik Elastomer Thermoplastic Elastomer		
Çalışma Sıcaklığı Operation Temperature	-15 / +70 (±2)	Kutu Adedi Pack. Unit	4		
Ağırlık Weight	392 Gr.				

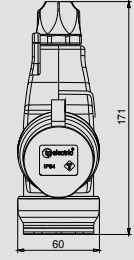
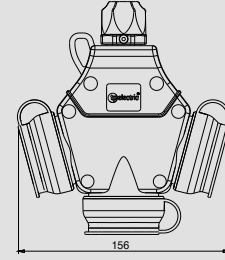

Üç Yönlü Grup Priz (Yaylı Kapak) 3-Way Group Socket (Press Lid)

IP54



Vidalı Bağlantı
Screw Connection

Kontakt-Amper Poles-Ampere	1x16A	Norm Version	Alman German	Ürün Kodu Cat. No	3101-320-0300
Faz Phase	Monofaze Mono Phase	Fransız French		3101-322-0300	
Voltaj Voltage	250V AC	Kontakt Malz. Contact Mat.	MS 70		
Kontakt Taşıma Gövdesi Contact Carrier	Polikarbonat Polycarbonate	Plastik Malzeme Plastic Material	Termoplastik Elastomer Thermoplastic Elastomer		
Çalışma Sıcaklığı Operation Temperature	-15 / +70 (±2)	Kutu Adedi Pack. Unit	4		
Ağırlık Weight	392 Gr.				

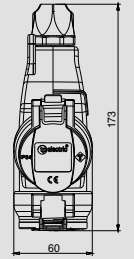
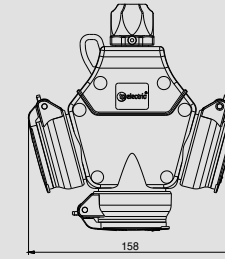

Uzatma Prizi (Geçmeli Kapak) Connector (Press Lid)

IP54



Vidalı Bağlantı
Screw Connection

Kontakt-Amper Poles-Ampere	3x16A	Norm Version	Alman German	Ürün Kodu Cat. No	3101-315-0300
Faz Phase	Trifaze Three Phase	Fransız French		3101-317-0300	
Voltaj Voltage	250V AC	Kontakt Malz. Contact Mat.	MS 70		
Kontakt Taşıma Gövdesi Contact Carrier	Polikarbonat Polycarbonate	Plastik Malzeme Plastic Material	Termoplastik Elastomer Thermoplastic Elastomer		
Çalışma Sıcaklığı Operation Temperature	-15 / +70 (±2)	Kutu Adedi Pack. Unit	4		
Ağırlık Weight	392 Gr.				

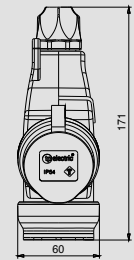
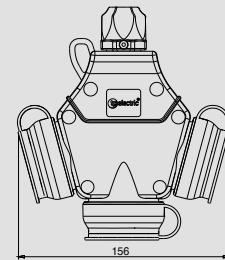

Uzatma Prizi (Yaylı Kapak) Connector (Screw Lid)

IP54



Vidalı Bağlantı
Screw Connection

Kontakt-Amper Poles-Ampere	3x16A	Norm Version	Alman German	Ürün Kodu Cat. No	3101-321-0300
Faz Phase	Trifaze Three Phase	Fransız French		3101-323-0300	
Voltaj Voltage	250V AC	Kontakt Malz. Contact Mat.	MS 70		
Kontakt Taşıma Gövdesi Contact Carrier	Polikarbonat Polycarbonate	Plastik Malzeme Plastic Material	Termoplastik Elastomer Thermoplastic Elastomer		
Çalışma Sıcaklığı Operation Temperature	-15 / +70 (±2)	Kutu Adedi Pack. Unit	4		
Ağırlık Weight	392 Gr.				

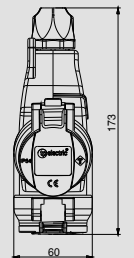
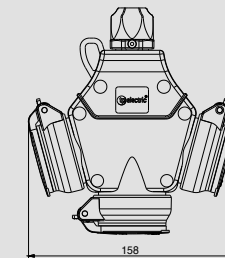

1x16A KAUÇUK DUVAR PRİZLERİ

1x16A RUBBER WALL SOCKETS

Ürün Kodu Cat. No	3101-306-0300	Kontakt-Amper Poles-Ampere	1x16A
Voltaj Voltage	250V AC	Kontakt Malz. Contact Mat.	MS 70
Kontakt Taşıma Gövdesi Contact Carrier	Polikarbonat Polycarbonate	Plastik Malzeme Plastic Material	Termoplastik Elastomer Thermoplastic Elastomer
Çalışma Sıcaklığı Operation Temperature	-15 / +70 (±2)	Kutu Adedi Pack. Unit	18
Ağırlık Weight	133 Gr.		

Duvar Prizi Surface Mount Socket Outlet

IP44



Vidalı Bağlantı
Screw Connection

Ürün Kodu Cat. No	3101-307-0300	Kontakt-Amper Poles-Ampere	1x16A
Voltaj Voltage	250V AC	Kontakt Malz. Contact Mat.	MS 70
Kontakt Taşıma Gövdesi Contact Carrier	Polikarbonat Polycarbonate	Plastik Malzeme Plastic Material	Termoplastik Elastomer Thermoplastic Elastomer
Çalışma Sıcaklığı Operation Temperature	-15 / +70 (±2)	Kutu Adedi Pack. Unit	16
Ağırlık Weight	114 Gr.		

Eğik Duvar Prizi Surface Mount Socket Outlet (Angled)

IP44



Vidalı Bağlantı
Screw Connection

MONOFAZE VE TRİFAZE BAĞLANTI DİYAGRAMI

SINGLE-PHASE AND THREE-PHASE CONNECTION DIAGRAM

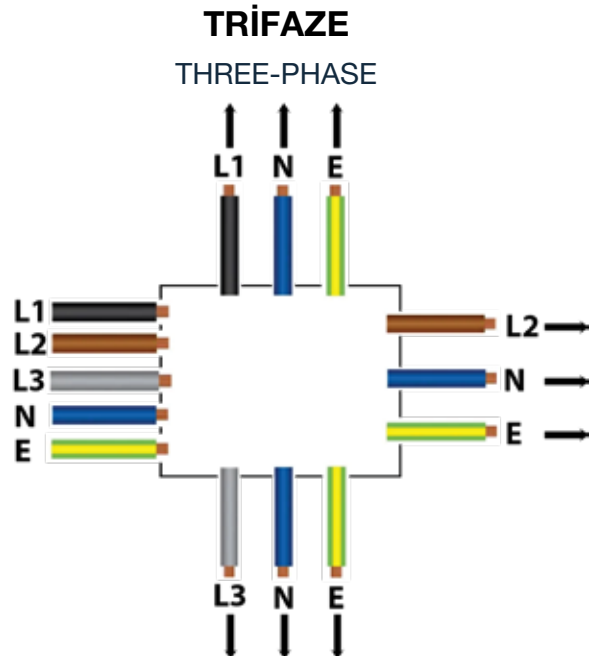
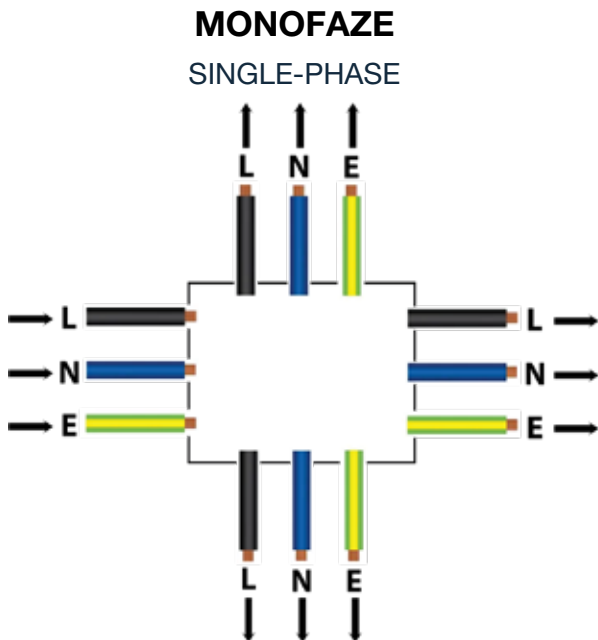

SEYYAR UYGULAMALAR İÇİN PANO PRİZİ / DIN 49440

PANEL SOCKET FOR PORTABLE APPLICATIONS / DIN 49440

Pano Prizi
Socket Outlet

IP54



Vidalı Bağlantı
Screw Connection

Kontakt-Amper Poles-Ampere	1x16A
Norm Version	Alman German (DIN) 
Voltaj Voltage	250V AC
Kontakt Malz. Contact Mat.	MS 70
Kontakt Taşıma Gövdesi Contact Carrier	Polikarbonat Polycarbonate
Plastik Malzeme Plastic Material	Poliamid Polyamide
Çalışma Sıcaklığı Operation Temperature	-15 / +70 (±2)
Kutu Adedi Pack. Unit	40
Ağırlık Weight	50 Gr.

Ürün Kodu Cat. No	3101-331-0900
-----------------------------	----------------------

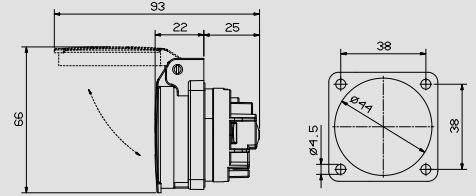

Pano Prizi
Socket Outlet

IP54



Hızlı Bağlantı
Quick Connection

Kontakt-Amper Poles-Ampere	1x16A
Norm Version	Alman German (DIN) 
Voltaj Voltage	250V AC
Kontakt Malz. Contact Mat.	MS 70
Kontakt Taşıma Gövdesi Contact Carrier	Polikarbonat Polycarbonate
Plastik Malzeme Plastic Material	Poliamid Polyamide
Çalışma Sıcaklığı Operation Temperature	-15 / +70 (±2)
Kutu Adedi Pack. Unit	40
Ağırlık Weight	50 Gr.

Ürün Kodu Cat. No	3101-337-0900
-----------------------------	----------------------

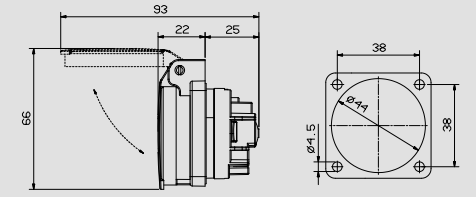

Pano Prizi
Socket Outlet

IP54



Vidalı Bağlantı
Screw Connection

Kontakt-Amper Poles-Ampere	1x16A
Norm Version	Alman German (DIN) 
Voltaj Voltage	250V AC
Kontakt Malz. Contact Mat.	MS 70
Kontakt Taşıma Gövdesi Contact Carrier	Polikarbonat Polycarbonate
Plastik Malzeme Plastic Material	Poliamid Polyamide
Çalışma Sıcaklığı Operation Temperature	-15 / +70 (±2)
Kutu Adedi Pack. Unit	40
Ağırlık Weight	50 Gr.

Ürün Kodu Cat. No	3101-333-0900
-----------------------------	----------------------

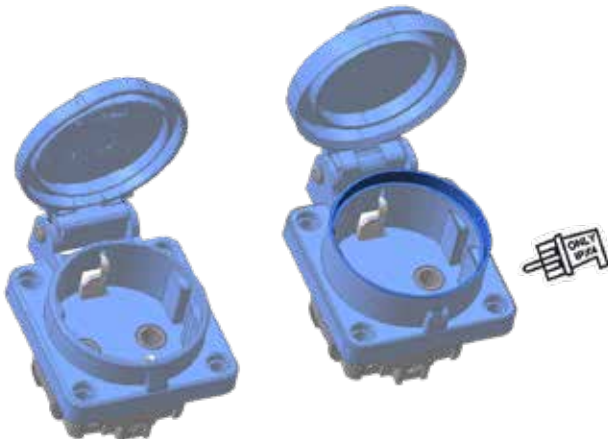
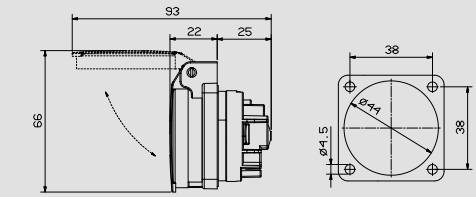









* Pano prizlerinden farklı olarak, seyyar uygulama pano prizlerinde bulunan sızdırmazlık kenarı, resimde koyu mavi renkle vurgulanmıştır.

* Unlike panel sockets, the sealing edge found in mobile application panel sockets is highlighted in dark blue in the image.

PANO PRİZLERİ

SOCKET OUTLETS

Ürün Kodu Cat. No	3101-310-0900 (Mavi - Blue)	Kontakt-Amper Poles-Ampere	1x16A
	3101-310-0300 (Siyah - Black)	Norm Version	Alman German (DIN) 
	3101-310-0600 (Gri - Grey)	Voltaj Voltage	250V AC
	3101-310-0300 (Siyah - Black)	Kontakt Malz. Contact Mat.	MS 70
	3101-310-0600 (Gri - Grey)	Kontakt Taşıma Gövdesi Contact Carrier	Polikarbonat Polycarbonate
	3101-310-0300 (Siyah - Black)	Plastik Malzeme Plastic Material	Poliamid Polyamide
	3101-310-0600 (Gri - Grey)	Çalışma Sıcaklığı Operation Temperature	-15 / +70 (±2)
	3101-310-0300 (Siyah - Black)	Kutu Adedi Pack. Unit	40
	3101-310-0600 (Gri - Grey)	Ağırlık Weight	50 Gr.

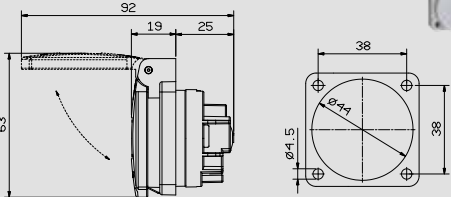









Pano Prizi

Socket Outlet

IP54



 **Vidalı Bağlantı**
Screw Connection

Ürün Kodu Cat. No	3101-334-0900 (Mavi - Blue)	Kontakt-Amper Poles-Ampere	1x16A
	3101-334-0300 (Siyah - Black)	Norm Version	Alman German (DIN) 
	3101-334-0600 (Gri - Grey)	Voltaj Voltage	250V AC
	3101-334-0300 (Siyah - Black)	Kontakt Malz. Contact Mat.	MS 70
	3101-334-0600 (Gri - Grey)	Kontakt Taşıma Gövdesi Contact Carrier	Polikarbonat Polycarbonate
	3101-334-0300 (Siyah - Black)	Plastik Malzeme Plastic Material	Poliamid Polyamide
	3101-334-0600 (Gri - Grey)	Çalışma Sıcaklığı Operation Temperature	-15 / +70 (±2)
	3101-334-0300 (Siyah - Black)	Kutu Adedi Pack. Unit	40
	3101-334-0600 (Gri - Grey)	Ağırlık Weight	50 Gr.

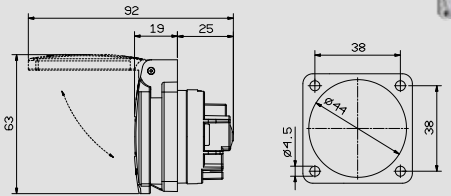











Pano Prizi

Socket Outlet

IP54



 **Hızlı Bağlantı**
Quick Connection

Ürün Kodu Cat. No	3101-332-0900 (Mavi - Blue)	Kontakt-Amper Poles-Ampere	1x16A
	3101-332-0300 (Siyah - Black)	Norm Version	Alman German (DIN) 
	3101-332-0600 (Gri - Grey)	Voltaj Voltage	250V AC
	3101-332-0300 (Siyah - Black)	Kontakt Malz. Contact Mat.	MS 70
	3101-332-0600 (Gri - Grey)	Kontakt Taşıma Gövdesi Contact Carrier	Polikarbonat Polycarbonate
	3101-332-0300 (Siyah - Black)	Plastik Malzeme Plastic Material	Poliamid Polyamide
	3101-332-0600 (Gri - Grey)	Çalışma Sıcaklığı Operation Temperature	-15 / +70 (±2)
	3101-332-0300 (Siyah - Black)	Kutu Adedi Pack. Unit	40
	3101-332-0600 (Gri - Grey)	Ağırlık Weight	50 Gr.

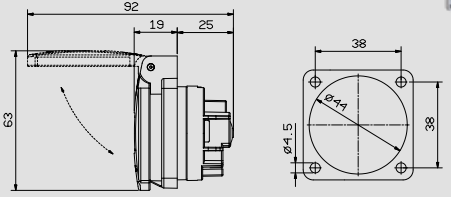







Pano Prizi

Socket Outlet

IP54



 **Vidalı Bağlantı**
Screw Connection

Ürün Kodu Cat. No	3101-336-0900 (Mavi - Blue)	Kontakt-Amper Poles-Ampere	1x16A
	3101-336-0300 (Siyah - Black)	Norm Version	Alman German (DIN) 
	3101-336-0600 (Gri - Grey)	Voltaj Voltage	250V AC
	3101-336-0300 (Siyah - Black)	Kontakt Malz. Contact Mat.	MS 70
	3101-336-0600 (Gri - Grey)	Kontakt Taşıma Gövdesi Contact Carrier	Polikarbonat Polycarbonate
	3101-336-0300 (Siyah - Black)	Plastik Malzeme Plastic Material	Poliamid Polyamide
	3101-336-0600 (Gri - Grey)	Çalışma Sıcaklığı Operation Temperature	-15 / +70 (±2)
	3101-336-0300 (Siyah - Black)	Kutu Adedi Pack. Unit	40
	3101-336-0600 (Gri - Grey)	Ağırlık Weight	50 Gr.

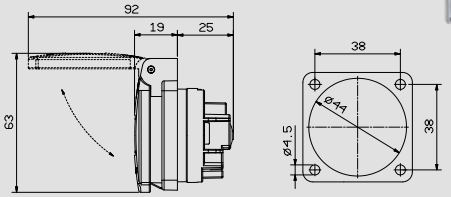

Pano Prizi

Socket Outlet

IP54



 **Hızlı Bağlantı**
Quick Connection

PANO PRİZLERİ

SOCKET OUTLETS

Pano Prizi
Socket Outlet

IP54



Vidalı Bağlantı
Screw Connection

Kontakt-Amper Poles-Ampere	1x16A
Norm Version	Fransız French 
Voltaj Voltage	250V AC
Kontakt Malz. Contact Mat.	MS 70 + MS 58 (Toprak) MS 70 + MS 58 (Earth)
Kontakt Taşıma Gövdesi Contact Carrier	Polikarbonat Polycarbonate
Plastik Malzeme Plastic Material	Poliamid Polyamide
Çalışma Sıcaklığı Operation Temperature	-15 / +70 (±2)
Kutu Adedi Pack. Unit	40
Ağırlık Weight	50 Gr.

Ürün Kodu
Cat. No

3101-326-0900
(Mavi - Blue)



3101-326-0300
(Siyah - Black)



3101-326-0600
(Gri - Grey)

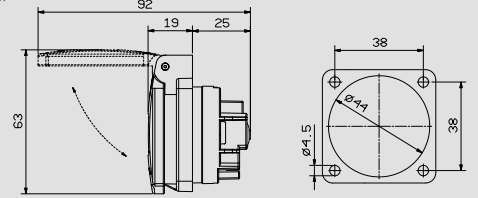

Pano Prizi
Socket Outlet

IP54



Hızlı Bağlantı
Quick Connection

Kontakt-Amper Poles-Ampere	1x16A
Norm Version	Fransız French 
Voltaj Voltage	250V AC
Kontakt Malz. Contact Mat.	MS 70 + MS 58 (Toprak) MS 70 + MS 58 (Earth)
Kontakt Taşıma Gövdesi Contact Carrier	Polikarbonat Polycarbonate
Plastik Malzeme Plastic Material	Poliamid Polyamide
Çalışma Sıcaklığı Operation Temperature	-15 / +70 (±2)
Kutu Adedi Pack. Unit	40
Ağırlık Weight	50 Gr.

Ürün Kodu
Cat. No

3101-338-0900
(Mavi - Blue)



3101-338-0300
(Siyah - Black)



3101-338-0600
(Gri - Grey)

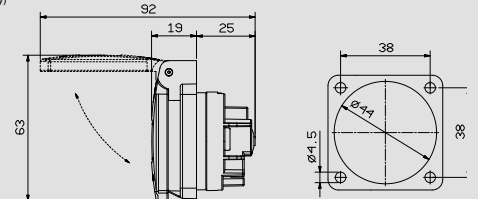

Pano Prizi
Socket Outlet

IP54



Vidalı Bağlantı
Screw Connection

Kontakt-Amper Poles-Ampere	1x16A
Norm Version	Danimarka Danish 
Voltaj Voltage	250V AC
Kontakt Malz. Contact Mat.	MS 70
Kontakt Taşıma Gövdesi Contact Carrier	Polikarbonat Polycarbonate
Plastik Malzeme Plastic Material	Poliamid Polyamide
Çalışma Sıcaklığı Operation Temperature	-15 / +70 (±2)
Kutu Adedi Pack. Unit	40
Ağırlık Weight	50 Gr.

Ürün Kodu
Cat. No

(Mavi - Blue)



3101-353-0900

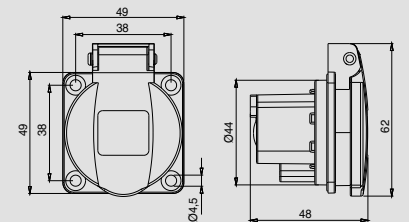

Pano Prizi
Socket Outlet

IP54



Vidalı Bağlantı
Screw Connection

Kontakt-Amper Poles-Ampere	1x16A
Norm Version	Danimarka Danish 
Voltaj Voltage	250V AC
Kontakt Malz. Contact Mat.	MS 70
Kontakt Taşıma Gövdesi Contact Carrier	Polikarbonat Polycarbonate
Plastik Malzeme Plastic Material	Poliamid Polyamide
Çalışma Sıcaklığı Operation Temperature	-15 / +70 (±2)
Kutu Adedi Pack. Unit	40
Ağırlık Weight	50 Gr.

Ürün Kodu
Cat. No

(Mavi - Blue)



3101-359-0900

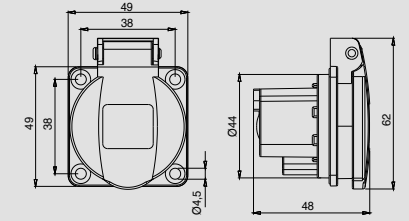

PANO PRİZLERİ

SOCKET OUTLETS

Ürün Kodu Cat. No	(Mavi - Blue) IP55	Ürün Kodu Cat. No	(Mavi - Blue) IP20	Kontakt-Amper Poles-Ampere	1x10A-16A
	3101-450-0900 (T13-10A)		3101-355-0900 (T13-10A)	Norm Version	İsviçre Swiss
	3101-455-0900 (T23-16A)		3101-357-0900 (T23-16A)	Volтаж Voltage	200 - 250V AC
				Kontakt Malz. Contact Mat.	MS 70
				Kontakt Taşıma Gövdesi Contact Carrier	Polikarbonat Polycarbonate
				Plastik Malzeme Plastic Material	Poliamid Polyamide
				Çalışma Sıcaklığı Operation Temperature	-15 / +70 (±2)
				Kutu Adedi Pack. Unit	40
				Ağırlık Weight	50 Gr.

İsviçre Normu Pano Prizi

Socket Outlet Swiss Version

IP55 **IP20**

New Standard

Vidalı Bağlantı
Screw Connection

Ürün Kodu Cat. No	(Kırmızı - Red) IP55	Ürün Kodu Cat. No	(Kırmızı - Red) IP20	Kontakt-Amper Poles-Ampere	3x10A-16A
	3101-460-1600 (T15-10A)		3101-358-1600 (T15-10A)	Norm Version	İsviçre Swiss
	3101-465-1600 (T25-16A)		3101-359-1600 (T25-16A)	Volтаж Voltage	250 - 400V AC
				Kontakt Malz. Contact Mat.	MS 70
				Kontakt Taşıma Gövdesi Contact Carrier	Polikarbonat Polycarbonate
				Plastik Malzeme Plastic Material	Poliamid Polyamide
				Çalışma Sıcaklığı Operation Temperature	-15 / +70 (±2)
				Kutu Adedi Pack. Unit	40
				Ağırlık Weight	50 Gr.

İsviçre Normu Pano Prizi

Socket Outlet Swiss Version

IP55 **IP20**

New Standard

Vidalı Bağlantı
Screw Connection

Ürün Kodu Cat. No	(Mavi - Blue)	Kontakt-Amper Poles-Ampere	1x13A
	3101-600-0900	Norm Version	İngiliz British
		Volтаж Voltage	200 - 250V AC
		Kontakt Malz. Contact Mat.	CuSn6
		Kontakt Taşıma Gövdesi Contact Carrier	Polikarbonat Polycarbonate
		Plastik Malzeme Plastic Material	Poliamid Polyamide
		Çalışma Sıcaklığı Operation Temperature	-15 / +70 (±2)
		Kutu Adedi Pack. Unit	40
		Ağırlık Weight	50 Gr.

Çocuk Korumalı
Child Protection

İngiliz Normu Pano Prizi

Socket Outlet British Version

IP54

Vidalı Bağlantı
Screw Connection

DUVAR TİPİ PANO PRİZLERİ

WALL MOUNT SOCKET OUTLETS

Duvar Tipi Pano Prizi
Wall Mount Socket Outlet

IP54



Vidalı Bağlantı
Screw Connection

Kontak-Amper Poles-Ampere	1x16A
Norm Version	Alman German (DIN) 
Voltaj Voltage	200 - 250V AC
Kontak Malz. Contact Mat.	MS 70
Kontak Taşıma Gövdesi Contact Carrier	Polikarbonat Polycarbonate
Plastik Malzeme Plastic Material	Poliamid Polyamide
Çalışma Sıcaklığı Operation Temperature	-15 / +70 (±2)
Kutu Adedi Pack. Unit	20
Ağırlık Weight	94 Gr.

Ürün Kodu
Cat. No

(Mavi - Blue)



3101-410-0900

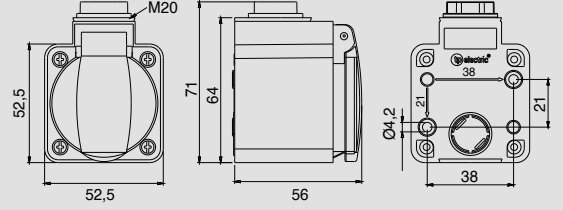

Duvar Tipi Pano Prizi
Wall Mount Socket Outlet

IP54



Vidalı Bağlantı
Screw Connection

Kontak-Amper Poles-Ampere	1x16A
Norm Version	Alman German (DIN) 
Voltaj Voltage	200 - 250V AC
Kontak Malz. Contact Mat.	MS 70
Kontak Taşıma Gövdesi Contact Carrier	Polikarbonat Polycarbonate
Plastik Malzeme Plastic Material	Poliamid Polyamide
Çalışma Sıcaklığı Operation Temperature	-15 / +70 (±2)
Kutu Adedi Pack. Unit	20
Ağırlık Weight	94 Gr.

Ürün Kodu
Cat. No

(Mavi - Blue)



3101-412-0900



Çocuk Korumalı
Child Protection

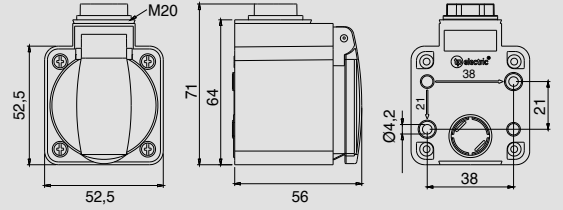

Duvar Tipi Pano Prizi
Wall Mount Socket Outlet

IP54



Hızlı Bağlantı
Quick Connection

Kontak-Amper Poles-Ampere	1x16A
Norm Version	Alman German (DIN) 
Voltaj Voltage	200 - 250V AC
Kontak Malz. Contact Mat.	MS 70
Kontak Taşıma Gövdesi Contact Carrier	Polikarbonat Polycarbonate
Plastik Malzeme Plastic Material	Poliamid Polyamide
Çalışma Sıcaklığı Operation Temperature	-15 / +70 (±2)
Kutu Adedi Pack. Unit	20
Ağırlık Weight	94 Gr.

Ürün Kodu
Cat. No

(Mavi - Blue)



3101-420-0900



Hızlı Bağlantı
Quick Connect

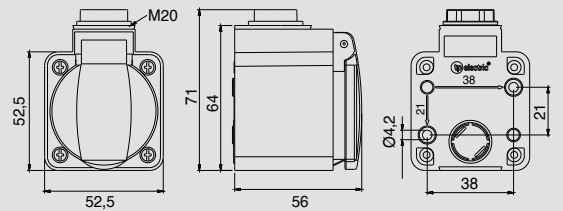

Duvar Tipi Pano Prizi
Wall Mount Socket Outlet

IP54



Hızlı Bağlantı
Quick Connection

Kontak-Amper Poles-Ampere	1x16A
Norm Version	Alman German (DIN) 
Voltaj Voltage	200 - 250V AC
Kontak Malz. Contact Mat.	MS 70
Kontak Taşıma Gövdesi Contact Carrier	Polikarbonat Polycarbonate
Plastik Malzeme Plastic Material	Poliamid Polyamide
Çalışma Sıcaklığı Operation Temperature	-15 / +70 (±2)
Kutu Adedi Pack. Unit	20
Ağırlık Weight	94 Gr.

Ürün Kodu
Cat. No

(Mavi - Blue)



3101-422-0900



Çocuk Korumalı
Child Protection



Hızlı Bağlantı
Quick Connect

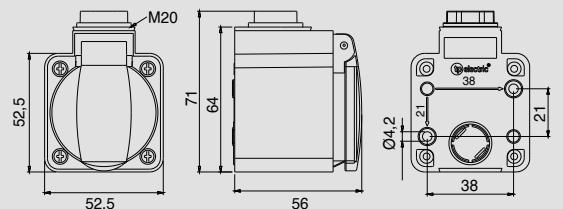

DUVAR TİPİ PANO PRİZLERİ

WALL MOUNT SOCKET OUTLETS

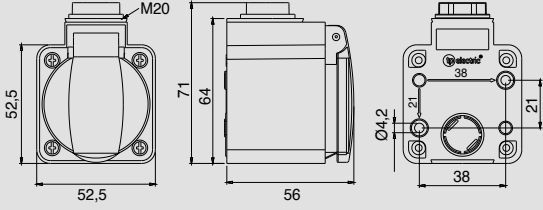

Ürün Kodu Cat. No	(Mavi - Blue)
	3101-414-0900

Kontakt-Amper Poles-Ampere	1x16A
Norm Version	Fransız French
Voltaj Voltage	200 - 250V AC
Kontakt Malz. Contact Mat.	MS 70 + MS 58 (Toprak) MS 70 + MS 58 (Earth)
Kontakt Taşıma Gövdesi Contact Carrier	Polikarbonat Polycarbonate
Plastik Malzeme Plastic Material	Poliamid Polyamide
Çalışma Sıcaklığı Operation Temperature	-15 / +70 (±2)
Kutu Adedi Pack. Unit	20
Ağırlık Weight	94 Gr.

Duvar Tipi Pano Prizi

Wall Mount Socket Outlet

IP54

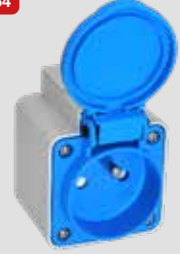

Vidalı Bağlantı
Screw Connection

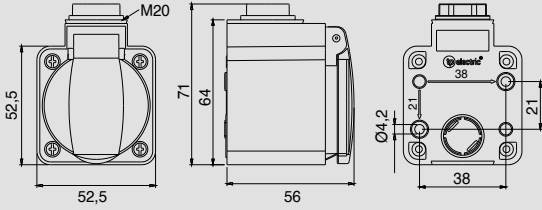

Ürün Kodu Cat. No	(Mavi - Blue)
	3101-424-0900

Kontakt-Amper Poles-Ampere	1x16A
Norm Version	Fransız French
Voltaj Voltage	200 - 250V AC
Kontakt Malz. Contact Mat.	MS 70 + MS 58 (Toprak) MS 70 + MS 58 (Earth)
Kontakt Taşıma Gövdesi Contact Carrier	Polikarbonat Polycarbonate
Plastik Malzeme Plastic Material	Poliamid Polyamide
Çalışma Sıcaklığı Operation Temperature	-15 / +70 (±2)
Kutu Adedi Pack. Unit	20
Ağırlık Weight	94 Gr.

Duvar Tipi Pano Prizi

Wall Mount Socket Outlet

IP54

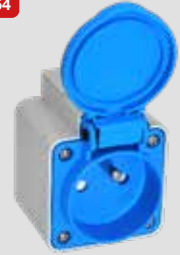

Hızlı Bağlantı
Quick Connection

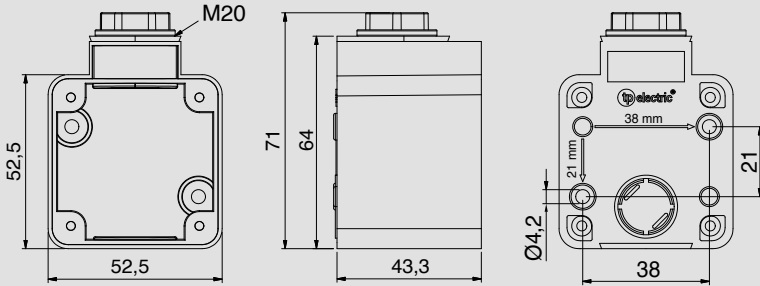

Ürün Kodu Cat. No	3101-430-0600
Kutu Adedi Pack. Unit	20
Ağırlık Weight	94 Gr.

Duvar Tipi Bağlantı Kutusu

Wall Mount Junction Box





MAKİNE PRİZLERİ

75x75 PANEL MOUNT SOCKET OUTLETS

Ürün Kodu Cat. No	(Mavi - Blue)
	3101-309-0900

Kontak-Amper Poles-Ampere	1x16A
Norm Version	Alman German (DIN) 
Voltaj Voltage	200 - 250V AC
Kontak Malz. Contact Mat.	MS 70
Kontak Taşıma Gövdesi Contact Carrier	Polikarbonat Polycarbonate
Plastik Malzeme Plastic Material	Poliamid Polyamide
Çalışma Sıcaklığı Operation Temperature	-15 / +70 (±2)
Kutu Adedi Pack. Unit	20
Ağırlık Weight	69 Gr.

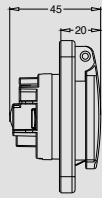
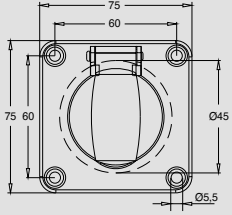

Makine Prizi Panel Mount Socket Outlet

IP54



Vidalı Bağlantı
Screw Connection

Ürün Kodu Cat. No	(Mavi - Blue)
	3101-340-0900

Kontak-Amper Poles-Ampere	1x16A
Norm Version	Fransız French 
Voltaj Voltage	200 - 250V AC
Kontak Malz. Contact Mat.	MS 70
Kontak Taşıma Gövdesi Contact Carrier	Polikarbonat Polycarbonate
Plastik Malzeme Plastic Material	Poliamid Polyamide
Çalışma Sıcaklığı Operation Temperature	-15 / +70 (±2)
Kutu Adedi Pack. Unit	20
Ağırlık Weight	69 Gr.

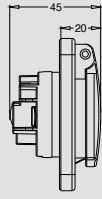
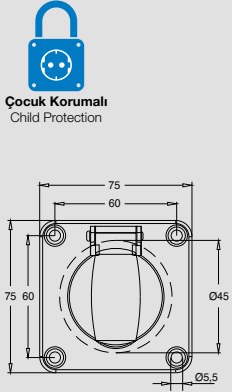



Makine Prizi Panel Mount Socket Outlet

IP54



Vidalı Bağlantı
Screw Connection

Ürün Kodu Cat. No	(Mavi - Blue)
	3101-344-0900

Kontak-Amper Poles-Ampere	1x16A
Norm Version	Fransız French 
Voltaj Voltage	200 - 250V AC
Kontak Malz. Contact Mat.	MS 70 + MS 58 (Toprak) MS 70 + MS 58 (Earth)
Kontak Taşıma Gövdesi Contact Carrier	Polikarbonat Polycarbonate
Plastik Malzeme Plastic Material	Poliamid Polyamide
Çalışma Sıcaklığı Operation Temperature	-15 / +70 (±2)
Kutu Adedi Pack. Unit	20
Ağırlık Weight	69 Gr.

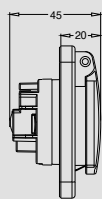
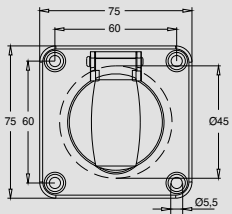

Makine Prizi Panel Mount Socket Outlet

IP54



Hızlı Bağlantı
Quick Connection

Ürün Kodu Cat. No	(Mavi - Blue)
	3101-346-0900

Kontak-Amper Poles-Ampere	1x16A
Norm Version	Fransız French 
Voltaj Voltage	200 - 250V AC
Kontak Malz. Contact Mat.	MS 70 + MS 58 (Toprak) MS 70 + MS 58 (Earth)
Kontak Taşıma Gövdesi Contact Carrier	Polikarbonat Polycarbonate
Plastik Malzeme Plastic Material	Poliamid Polyamide
Çalışma Sıcaklığı Operation Temperature	-15 / +70 (±2)
Kutu Adedi Pack. Unit	20
Ağırlık Weight	69 Gr.

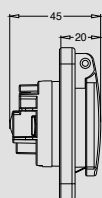
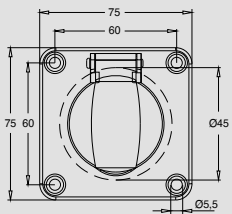

Makine Prizi Panel Mount Socket Outlet

IP54



Hızlı Bağlantı
Quick Connection

RAYA MONTAJ PRİZLER

DIN RAIL MOUNT SOCKET OUTLETS

Raya Montaj Priz Rail Mount Socket Outlet

IP20



Vidalı Bağlantı
Screw Connection

Kontakt-Amper Poles-Ampere	1x16A
Norm Version	Alman German (DIN) 
Voltaj Voltage	200 - 250V AC
Kontakt Malz. Contact Mat.	MS 70
Kontakt Taşıma Gövdesi Contact Carrier	Poliamid Polyamide
Plastik Malzeme Plastic Material	Poliamid Polyamide
Çalışma Sıcaklığı Operation Temperature	-15 / +70 (±2)
Kutu Adedi Pack. Unit	30
Ağırlık Weight	88 Gr.

Ürün Kodu
Cat. No

3101-312-0600

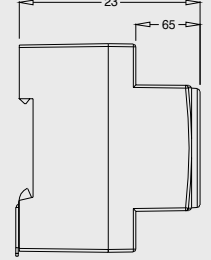
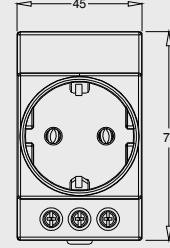

Raya Montaj Priz (Ledli) Rail Mount Socket Outlet (With Led)

IP20



Vidalı Bağlantı
Screw Connection

Kontakt-Amper Poles-Ampere	1x16A
Norm Version	Alman German (DIN) 
Voltaj Voltage	200 - 250V AC
Kontakt Malz. Contact Mat.	MS 70
Kontakt Taşıma Gövdesi Contact Carrier	Poliamid Polyamide
Plastik Malzeme Plastic Material	Poliamid Polyamide
Çalışma Sıcaklığı Operation Temperature	-15 / +70 (±2)
Kutu Adedi Pack. Unit	30
Ağırlık Weight	88 Gr.

Ürün Kodu
Cat. No

3101-312-0610

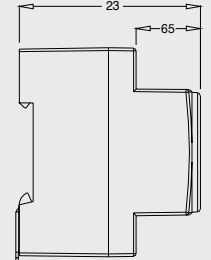
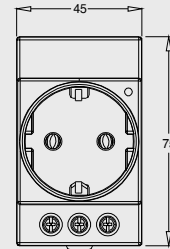

Raya Montaj Priz Rail Mount Socket Outlet

IP20



Vidalı Bağlantı
Screw Connection

Kontakt-Amper Poles-Ampere	1x16A
Norm Version	Fransız French 
Voltaj Voltage	200 - 250V AC
Kontakt Malz. Contact Mat.	MS 70 + MS 58 (Toprak) MS 70 + MS 58 (Earth)
Kontakt Taşıma Gövdesi Contact Carrier	Poliamid Polyamide
Plastik Malzeme Plastic Material	Poliamid Polyamide
Çalışma Sıcaklığı Operation Temperature	-15 / +70 (±2)
Kutu Adedi Pack. Unit	30
Ağırlık Weight	88 Gr.

Ürün Kodu
Cat. No

3101-327-0600

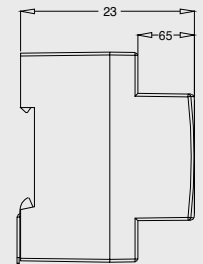
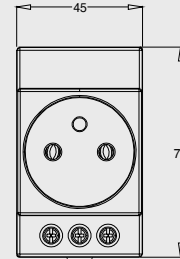

Raya Montaj Priz (Ledli) Rail Mount Socket Outlet (With Led)

IP20



Vidalı Bağlantı
Screw Connection

Kontakt-Amper Poles-Ampere	1x16A
Norm Version	Fransız French 
Voltaj Voltage	200 - 250V AC
Kontakt Malz. Contact Mat.	MS 70 + MS 58 (Toprak) MS 70 + MS 58 (Earth)
Kontakt Taşıma Gövdesi Contact Carrier	Poliamid Polyamide
Plastik Malzeme Plastic Material	Poliamid Polyamide
Çalışma Sıcaklığı Operation Temperature	-15 / +70 (±2)
Kutu Adedi Pack. Unit	30
Ağırlık Weight	88 Gr.

Ürün Kodu
Cat. No

3101-327-0610

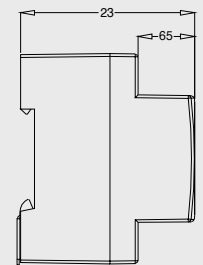
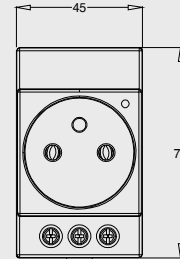

İNCE FİŞLER SLIM PLUGS

Ürün Kodu Cat. No	EV100101	Kontakt-Amper Poles-Ampere	1x16A
Norm Version	Alman German (DIN)	Kontakt Taşıma Gövdesi Contact Carrier	Polikarbonat Polycarbonate
Voltaj Voltage	200 - 250V AC	Plastik Malzeme Plastic Material	Termoplastik Elastomer Thermoplastic Elastomer
Çalışma Sıcaklığı Operation Temperature	-15 / +70 (±2)	Kutu Adedi Pack. Unit	50
Ağırlık Weight	135 Gr.		



İnce Fiş (Beyaz) Slim Plug (White)

IP20



Vidalı Bağlantı
Screw Connection

Ürün Kodu Cat. No	EV100102	Kontakt-Amper Poles-Ampere	1x16A
Norm Version	Alman German (DIN)	Kontakt Taşıma Gövdesi Contact Carrier	Polikarbonat Polycarbonate
Voltaj Voltage	200 - 250V AC	Plastik Malzeme Plastic Material	Termoplastik Elastomer Thermoplastic Elastomer
Çalışma Sıcaklığı Operation Temperature	-15 / +70 (±2)	Kutu Adedi Pack. Unit	50
Ağırlık Weight	135 Gr.		



İnce Fiş (Siyah) Slim Plug (Black)

IP20



Vidalı Bağlantı
Screw Connection



5 mm ile hayatınıza yer açın.
Open up space in your life with 5 mm.

SEYYAR EL LAMBASI PORTABLE HAND LAMPS

Sey. El Lambası
Por. Hand Lamp

IP20



Vidalı Bağlantı
Screw Connection

Kontakt-Amper Poles-Ampere	1x2A
Voltaj Voltage	200 - 250V AC
Çalışma Sıcaklığı Operation Temperature	-15 / +70 (±2)
Kutu Adedi Pack. Unit	4
Ağırlık Weight	434 Gr.

Ürün Kodu
Cat. No

3116-401-0300

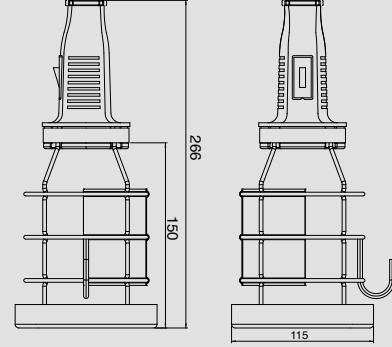

Sey. El Lambası (Anahtarlı)
Por. Hand Lamp (With Switch)

IP20



Vidalı Bağlantı
Screw Connection

Kontakt-Amper Poles-Ampere	1x2A
Voltaj Voltage	200 - 250V AC
Çalışma Sıcaklığı Operation Temperature	-15 / +70 (±2)
Kutu Adedi Pack. Unit	4
Ağırlık Weight	440 Gr.

Ürün Kodu
Cat. No

3116-402-0300

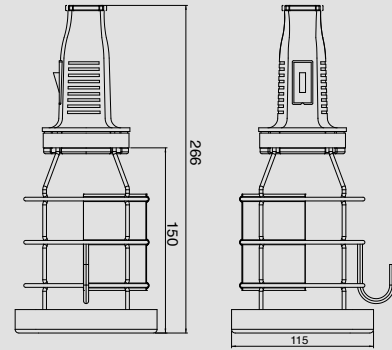

Sey. El Lambası (Kablolu)
Por. Hand Lamp (With Cabled)

IP20



Vidalı Bağlantı
Screw Connection

Kontakt-Amper Poles-Ampere	1x2A
Voltaj Voltage	200 - 250V AC
Çalışma Sıcaklığı Operation Temperature	-15 / +70 (±2)
Kablo Uzunluğu Cable Length	10 mt.
Kutu Adedi Pack. Unit	4
Ağırlık Weight	434 Gr.

Ürün Kodu
Cat. No

3116-401-0310

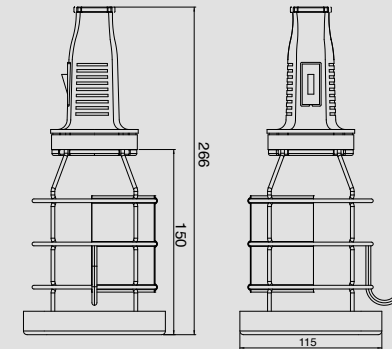

Sey. El Lam. (Anahtarlı + Kablolu)
Por. Hand Lamp
(With Switch + Cabled)

IP20



Vidalı Bağlantı
Screw Connection

Kontakt-Amper Poles-Ampere	1x2A
Voltaj Voltage	200 - 250V AC
Çalışma Sıcaklığı Operation Temperature	-15 / +70 (±2)
Kablo Uzunluğu Cable Length	10 mt.
Kutu Adedi Pack. Unit	4
Ağırlık Weight	434 Gr.

Ürün Kodu
Cat. No

3116-402-0310

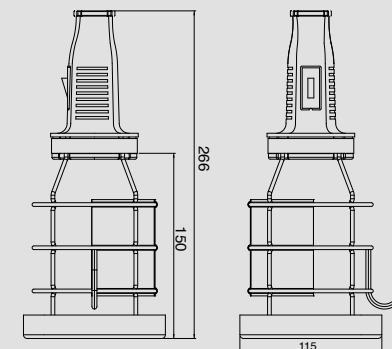

IP68 FİŞ PRİZLER

IP68 PLUGS AND SOCKETS



TOZ GEÇİRMEZ
DUST-TIGHT

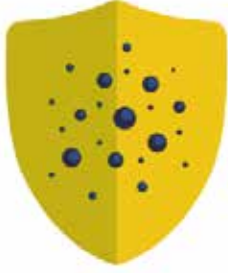

[**IP 68**]

SU GEÇİRMEZ
WATER-TIGHT



IP 68 Koruma sınıfı
IP 68 Protection class

2 Bar / 2h
2 Bar / 2h

Su ve toz geçirmez
Watertight and dusttight



IP68 FİŞLER

IP68 PLUGS

IP 68 Düz Fiş

IP68 Plug

IP68



Vidalı Bağlantı
Screw Connection

Kontakt-Amper Poles-Ampere	1x16A
Voltaj Voltage	200 - 250V AC
Kontakt Malz. Contact Mat.	Nikel Kaplama Nickel Plated
Kontakt Taşıma Gövdesi Contact Carrier	Polikarbonat Polycarbonate
Plastik Malzeme Plastic Material	PA6
Çalışma Sıcaklığı Operation Temperature	-15 / +70 (±2)
Kutu Adedi Pack. Unit	15
Ağırlık Weight	126 Gr.

Norm Version	Ürün Kodu Cat. No
Alman German	3101-365-0900
Fransız French	3101-367-0900

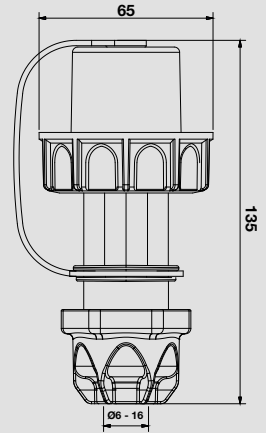

IP 68 Makine Fişi

IP68 Panel Mount Appliance Inlet

IP68



Vidalı Bağlantı
Screw Connection

Kontakt-Amper Poles-Ampere	1x16A
Voltaj Voltage	200 - 250V AC
Kontakt Malz. Contact Mat.	Nikel Kaplama Nickel Plated
Kontakt Taşıma Gövdesi Contact Carrier	Polikarbonat Polycarbonate
Plastik Malzeme Plastic Material	PA6
Çalışma Sıcaklığı Operation Temperature	-15 / +70 (±2)
Kutu Adedi Pack. Unit	10
Ağırlık Weight	154 Gr.

Norm Version	Ürün Kodu Cat. No
Alman German	3101-400-0900
Fransız French	3101-402-0900

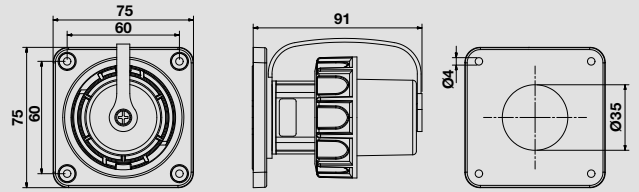

IP 68 Duvar Fişi

IP68 Surface Mount App. Inlet

IP68



Vidalı Bağlantı
Screw Connection

Kontakt-Amper Poles-Ampere	1x16A
Voltaj Voltage	200 - 250V AC
Kontakt Malz. Contact Mat.	Nikel Kaplama Nickel Plated
Kontakt Taşıma Gövdesi Contact Carrier	Polikarbonat Polycarbonate
Plastik Malzeme Plastic Material	PA6
Çalışma Sıcaklığı Operation Temperature	-15 / +70 (±2)
Kutu Adedi Pack. Unit	10
Ağırlık Weight	228 Gr.

Norm Version	Ürün Kodu Cat. No
Alman German	3101-403-0900
Fransız French	3101-404-0900

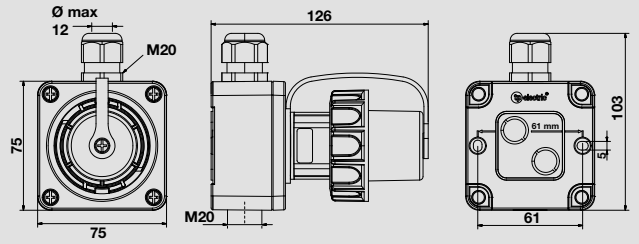

IP 68 Eğik Duvar Fişi

IP68 Surface Mount Inlet (Angled)

IP68



Vidalı Bağlantı
Screw Connection

Kontakt-Amper Poles-Ampere	1x16A
Voltaj Voltage	200 - 250V AC
Kontakt Malz. Contact Mat.	Nikel Kaplama Nickel Plated
Kontakt Taşıma Gövdesi Contact Carrier	Polikarbonat Polycarbonate
Plastik Malzeme Plastic Material	PA6
Çalışma Sıcaklığı Operation Temperature	-15 / +70 (±2)
Kutu Adedi Pack. Unit	5
Ağırlık Weight	261 Gr.

Norm Version	Ürün Kodu Cat. No
Alman German	3101-405-0900
Fransız French	3101-407-0900

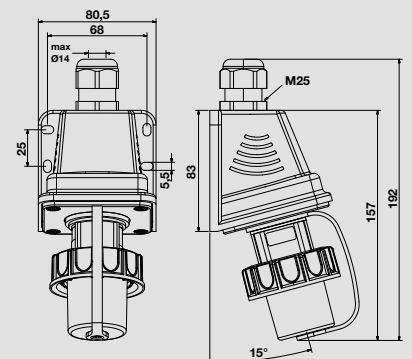

IP68 PRİZLER

IP68 SOCKETS

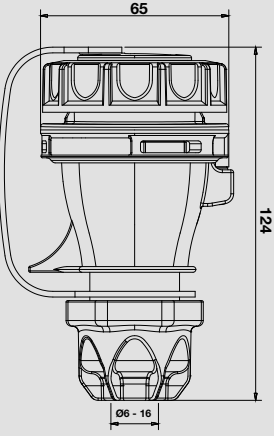

Norm Version	Ürün Kodu Cat. No
Alman German	3101-370-0900
Fransız French	3101-372-0900

Kontak-Amper Poles-Ampere	1x16A
Voltaj Voltage	200 - 250V AC
Kontak Malz. Contact Mat.	MS 58
Kontak Taşıma Gövdesi Contact Carrier	Polikarbonat Polycarbonate
Plastik Malzeme Plastic Material	PA6
Çalışma Sıcaklığı Operation Temperature	-15 / +70 (±2)
Kutu Adedi Pack. Unit	15
Ağırlık Weight	130 Gr.

IP 68 Uzatma Prizi IP68 Connector

IP68



Vidalı Bağlantı
Screw Connection

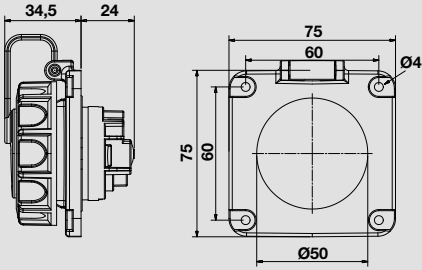

Norm Version	Ürün Kodu Cat. No
Alman German	3101-375-0900
Fransız French	3101-377-0900

Kontak-Amper Poles-Ampere	1x16A
Voltaj Voltage	200 - 250V AC
Kontak Malz. Contact Mat.	MS 58
Kontak Taşıma Gövdesi Contact Carrier	Polikarbonat Polycarbonate
Plastik Malzeme Plastic Material	PA6
Çalışma Sıcaklığı Operation Temperature	-15 / +70 (±2)
Kutu Adedi Pack. Unit	15
Ağırlık Weight	103 Gr.

IP 68 Makine Prizi IP68 Panel Mount Socket Outlet

IP68



Vidalı Bağlantı
Screw Connection

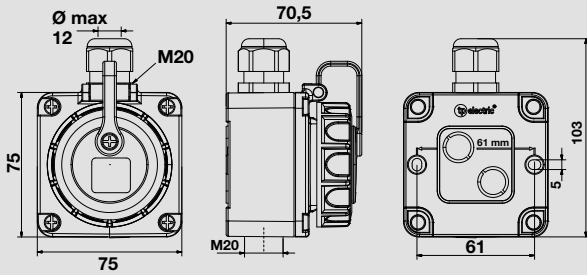

Norm Version	Ürün Kodu Cat. No
Alman German	3101-380-0900
Fransız French	3101-382-0900

Kontak-Amper Poles-Ampere	1x16A
Voltaj Voltage	200 - 250V AC
Kontak Malz. Contact Mat.	MS 58
Kontak Taşıma Gövdesi Contact Carrier	Polikarbonat Polycarbonate
Plastik Malzeme Plastic Material	PA6
Çalışma Sıcaklığı Operation Temperature	-15 / +70 (±2)
Kutu Adedi Pack. Unit	5
Ağırlık Weight	167 Gr.

IP 68 Duvar Prizi IP68 Surface Mount Socket Outlet

IP68



Vidalı Bağlantı
Screw Connection

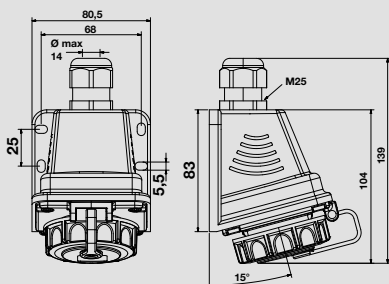

Norm Version	Ürün Kodu Cat. No
Alman German	3101-385-0900
Fransız French	3101-387-0900

Kontak-Amper Poles-Ampere	1x16A
Voltaj Voltage	200 - 250V AC
Kontak Malz. Contact Mat.	MS 58
Kontak Taşıma Gövdesi Contact Carrier	Polikarbonat Polycarbonate
Plastik Malzeme Plastic Material	PA6
Çalışma Sıcaklığı Operation Temperature	-15 / +70 (±2)
Kutu Adedi Pack. Unit	5
Ağırlık Weight	196 Gr.

IP 68 Eğik Duvar Prizi IP68 Surface Mount Socket (Angled)

IP68



Vidalı Bağlantı
Screw Connection



NEMLİYER ANAHTAR VE PRİZLER

WEATHER PROOF PRODUCTS

ANAHTAR GRUBU

SWITCHES

1- Anahtar düğme
Switch button

2- Kapak
Cover

3- Kontak taşıma gövdesi
Contact carrier

4- Conta
Gasket

5- Sabitleme vidası
Fixing screw

6- Gövde
Housing

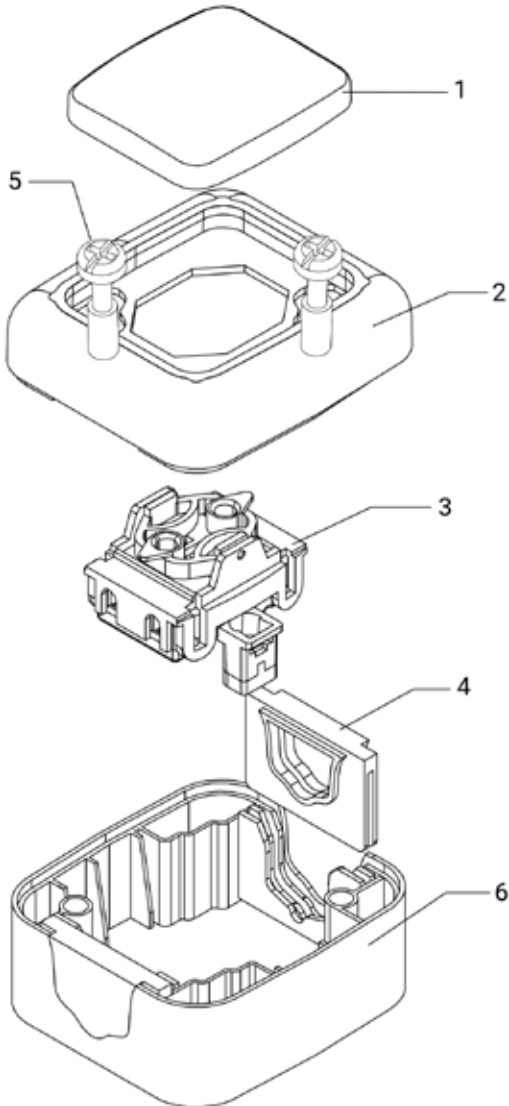

PRİZ GRUBU

SOCKETS

1- Priz kapağı
Socket Cover

2- Kapak
Cover

3- Kontak taşıma gövdesi
Contact carrier

4- Conta
Gasket

5- Sabitleme vidası
Fixing screw

6- Gövde
Housing

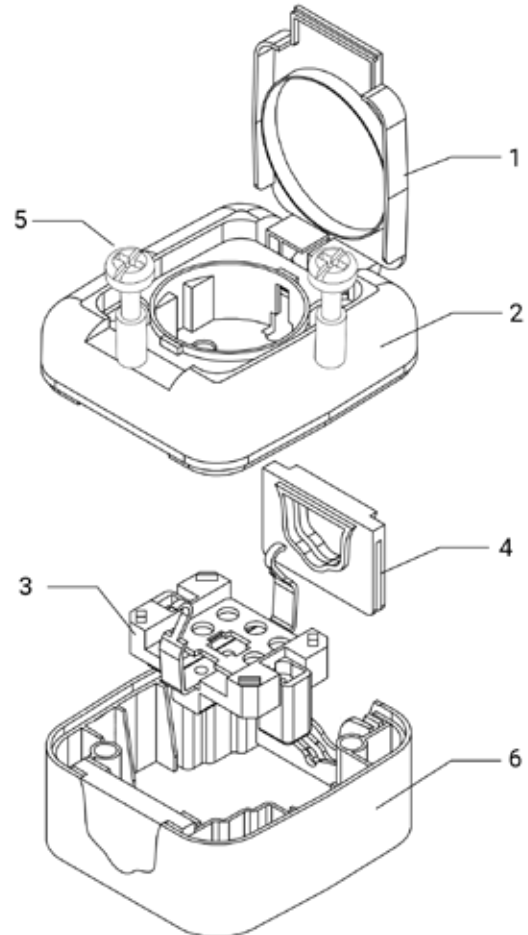

TEKLI ÜRÜN ÖLÇÜLERİ

DIMENSIONS OF SINGLE PRODUCTS

Anahtar Switch	3201-001-0601	
Vavien Vavien	3201-003-0601	
Çağırma (Light) Push Button	3201-004-0601	
Çift Yollu Anahtar Bipolar Switch	3201-005-0601	
Permütatör Cross Switch	3201-006-0601	
Zil İşaretili Çağırma Push Button With Indication Bell	3201-012-0601	
Merdiven İşaretili Çağırma Push Button With Indication Stairway	3201-013-0601	

Komitatör Two Way Switch	3201-002-0601	
Jaluzi Kumanda Venetian Blind Switch	3201-007-0601	
Komitatör Vavien Two Way Switch Vavien	3201-017-0601	

İşıklı Anahtar Switch With Light	3201-008-0601	
İşıklı Vavien Vavien With Light	3201-009-0601	
İşıklı Çağırma Push Button With Light	3201-010-0601	
İşıklı Merdiven İşaretili Çağırma Push Button With Light And Stairway	3201-015-0601	

İşıklı Komitatör Two Way Switch With Light	3201-021-0601	
--	---------------	--

Priz (Alman/DIN Norm) Socket (German/DIN Norm)	3201-025-0601	
Priz (Fransız Normu) Socket (French Type)	3201-033-0601	
Priz (İngiliz Normu) Socket (British Type)	3202-025-0600	
Telefon Prizi Telephone Socket	3201-041-0600	
Data Prizi Data Socket	3201-053-0600	
TV Prizi (Sonlu) TV Socket With Finite	3201-066-0600	
TV Prizi (Geçişli) TV Socket With Transantative	3201-088-0600	
TV Uydu Prizi TV Satellite Socket	3201-069-0600	

İKİLİ YATAY ÜRÜN ÖLÇÜLERİ

DIMENSIONS OF HORIZONTAL GROUP

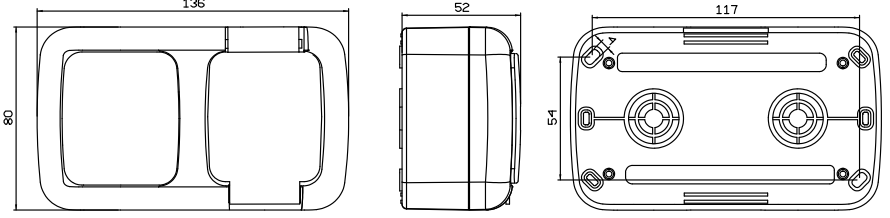
Anahtar + Priz Switch + Socket	3201-101-0601	
Vavien + Priz Vavien + Socket	3201-103-0601	
Çağırma + Priz Push Button + Socket	3201-104-0601	
Çift Yollu Anahtar + Priz Bipolar Switch + Socket	3201-105-0601	

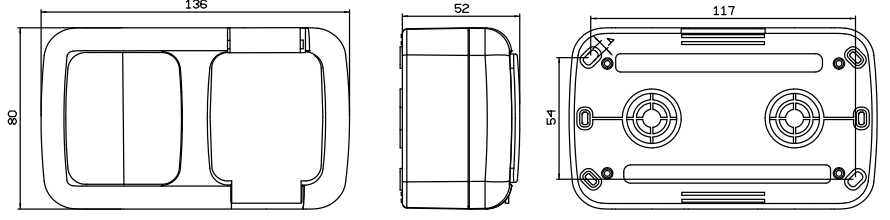
Komitatör + Priz Two Way Switch + Socket	3201-102-0601	

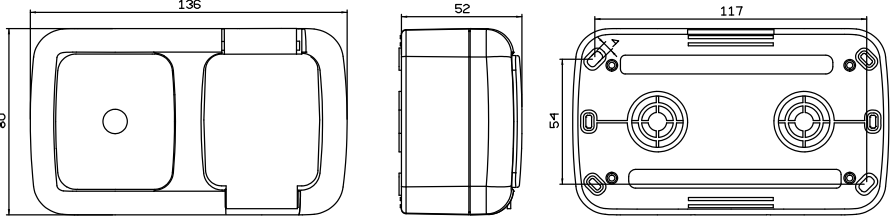
Işıklı Anahtar + Priz Switch With Light + Socket	3201-108-0601	
Işıklı Çağırma + Priz Push Button With Light + Socket	3201-110-0601	

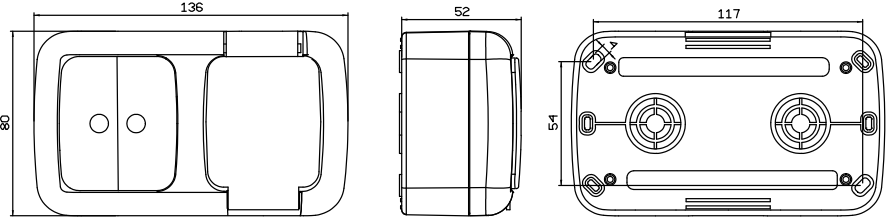
Işıklı Komitatör + Priz Two Way Switch With Light + Socket	3201-121-0601	

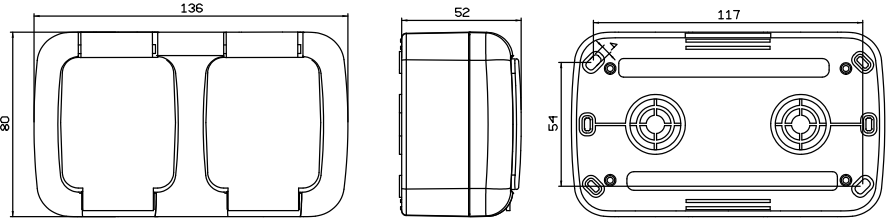
Priz + Priz Socket + Socket	3201-125-0601	

İKİLİ DIKEY ÜRÜN ÖLÇÜLERİ DIMENSIONS OF VERTICAL GROUP

Anahtar + Priz Switch + Socket	3201-301-0601	
Vavien + Priz Vavien + Socket	3201-303-0601	
Çağırma + Priz Push Button + Socket	3201-304-0601	
Çift Yollu Anahtar + Priz Bipolar Switch + Socket	3201-305-0601	

Komitatör + Priz Two Way Switch + Socket	3201-302-0601	
--	---------------	--

İşıkli Anahtar + Priz Switch With Light + Socket	3201-308-0601	
İşıkli Çağırma + Priz Push Button With Light + Socket	3201-310-0601	

İşıkli Komitatör + Priz Two Way Switch With Light + Socket	3201-321-0601	
--	---------------	--

Priz + Priz Socket + Socket	3201-325-0601	
---------------------------------------	---------------	--



NEMLİYER ANAHTARLAR

WEATHER PROOF SWITCHES

Anahtar
One Way Switch

IP54



Ürün Kodu Cat. No	3201-001-0601
Maksimum Amper Maximum Ampere	10A
Voltaj Voltage	250V AC
Kutu Adedi Pack. Unit	10
Ağırlık Weight	100 Gr.

Bir lamba veya lamba grubunu tek yerden kumanda eder.
It controls a lamp or lamp group from one place.

Bağlantı Şeması
Wiring Diagram

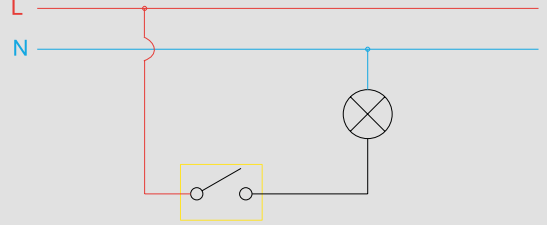

Komitör
Two Way Switch

IP54



Ürün Kodu Cat. No	3201-002-0601
Maksimum Amper Maximum Ampere	10A
Voltaj Voltage	250V AC
Kutu Adedi Pack. Unit	10
Ağırlık Weight	100 Gr.

İki ayrı lamba veya lamba grubunu tek yerden kumanda eder.
It controls two separate lamps or lamp groups from one place.

Bağlantı Şeması
Wiring Diagram

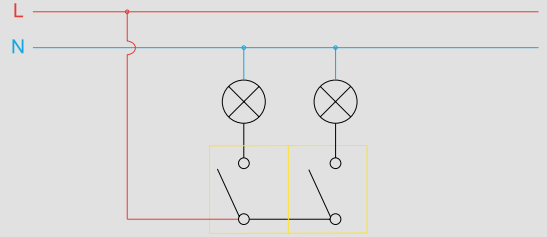

Vavien
Vavien

IP54



Ürün Kodu Cat. No	3201-003-0601
Maksimum Amper Maximum Ampere	10A
Voltaj Voltage	250V AC
Kutu Adedi Pack. Unit	10
Ağırlık Weight	100 Gr.

Bir lamba veya lamba grubunu iki ayrı yerden kumanda eder.
It controls a lamp or lamp group from two different places.

Bağlantı Şeması
Wiring Diagram

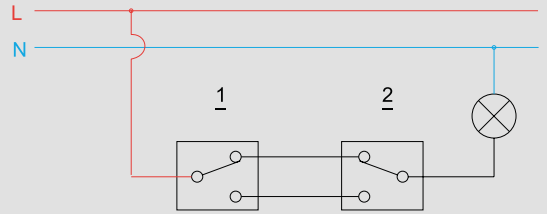

Çağırma (Light)
Pust button

IP54



Ürün Kodu Cat. No	3201-004-0601
Maksimum Amper Maximum Ampere	10A
Voltaj Voltage	250V AC
Kutu Adedi Pack. Unit	10
Ağırlık Weight	100 Gr.

Bir lamba veya lamba grubunu kumanda eden merdiven otomatığını harekete geçirir.
It activates the ladder automatic that controls a lamp or lamp group.

Bağlantı Şeması
Wiring Diagram

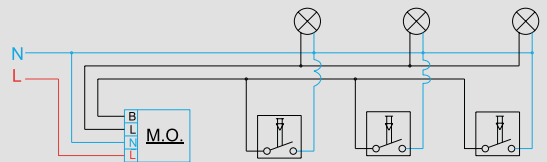

Çift Yolu Anahtar
Bipolar Switch

IP54



Ürün Kodu Cat. No	3201-005-0601
Maksimum Amper Maximum Ampere	10A
Voltaj Voltage	250V AC
Kutu Adedi Pack. Unit	10
Ağırlık Weight	100 Gr.

İki ayrı lamba veya lamba grubunu iki ayrı yerden aynı anda kumanda eder.
It controls two different lamps or lamp groups from two different places at the same time.

Bağlantı Şeması
Wiring Diagram

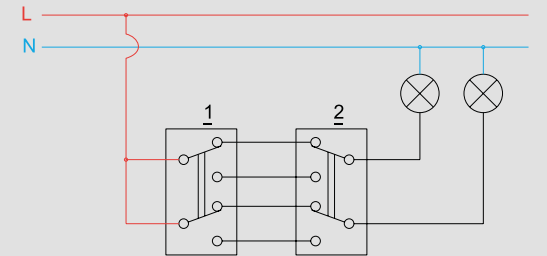

NEMLİYER ANAHTARLAR

WEATHER PROOF SWITCHES

Bağlantı Şeması
Wiring Diagram

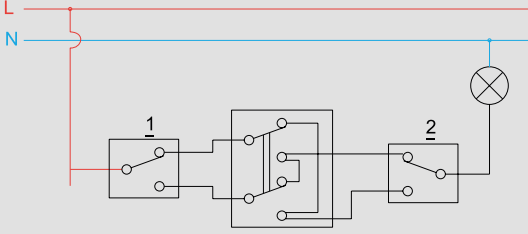

Ürün Kodu Cat. No	3201-006-0601
Maksimum Amper Maximum Ampere	10A
Voltaaj Voltage	250V AC
Kutu Adedi Pack. Unit	10
Ağırlık Weight	100 Gr.

Bir lamba veya lamba grubunu ikiden fazla yerden kumanda eder.
It controls a lamp or lamp group from more than two places.

Permütatör
Cross Switch

IP54



Bağlantı Şeması
Wiring Diagram

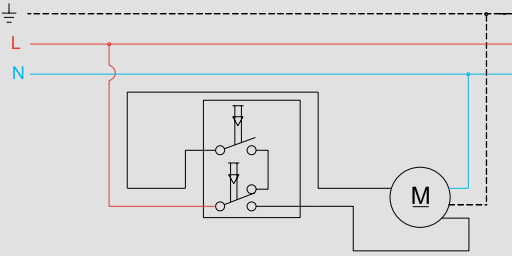

Ürün Kodu Cat. No	3201-007-0601
Maksimum Amper Maximum Ampere	10A
Voltaaj Voltage	250V AC
Kutu Adedi Pack. Unit	10
Ağırlık Weight	100 Gr.

Jaluzinin yukarı ve aşağı yönde hareketini kumanda eder.
It controls the up and down movement of the blind.

Jaluzi Kumanda
Venetian Blind Switch

IP54



Bağlantı Şeması
Wiring Diagram

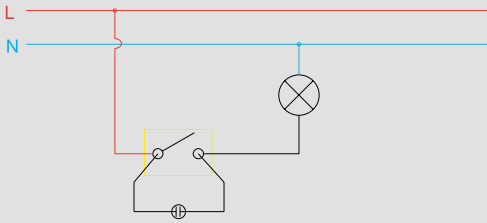

Ürün Kodu Cat. No	3201-008-0601
Maksimum Amper Maximum Ampere	10A
Voltaaj Voltage	250V AC
Kutu Adedi Pack. Unit	10
Ağırlık Weight	100 Gr.

Bir lamba veya lamba grubunu tek yerden kumanda eder.
It controls a lamp or lamp group from one place.

Işıklı Anahtar
Switch With Light

IP54



Bağlantı Şeması
Wiring Diagram

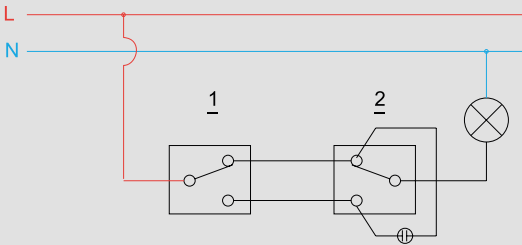

Ürün Kodu Cat. No	3201-009-0601
Maksimum Amper Maximum Ampere	10A
Voltaaj Voltage	250V AC
Kutu Adedi Pack. Unit	10
Ağırlık Weight	100 Gr.

Bir lamba veya lamba grubunu iki ayrı yerden kumanda eder.
It controls a lamp or lamp group from two different places.

Işıklı Vavien
Vavien With Light

IP54



Bağlantı Şeması
Wiring Diagram

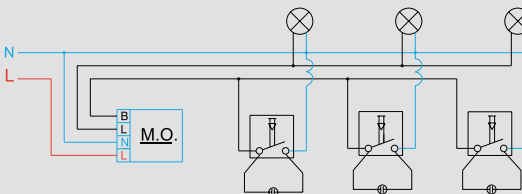

Ürün Kodu Cat. No	3201-010-0601
Maksimum Amper Maximum Ampere	10A
Voltaaj Voltage	250V AC
Kutu Adedi Pack. Unit	10
Ağırlık Weight	100 Gr.

Bir lamba veya lamba grubunu kumanda eden merdiven otomatini harekete geçirir.
It activates the ladder automatic that controls a lamp or lamp group.

Işıklı Çağırma
Push Button With Light

IP54



NEMLİYER ANAHTARLAR

WEATHER PROOF SWITCHES

Zil İşaretli Çağırma

Push Button With Indication Bell

IP54



Ürün Kodu Cat. No	3201-012-0601
Maksimum Amper Maximum Ampere	10A
Voltaj Voltage	250V AC
Kutu Adedi Pack. Unit	10
Ağırlık Weight	100 Gr.

Bağlantı Şeması

Wiring Diagram

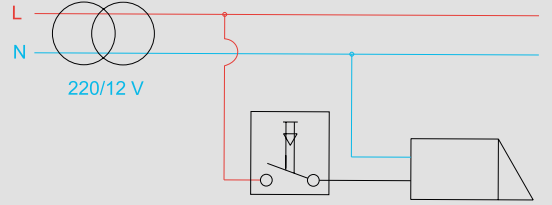

Merdiven İşaretli Çağırma

Push Button With Indication Stairway

IP54



Ürün Kodu Cat. No	3201-013-0601
Maksimum Amper Maximum Ampere	10A
Voltaj Voltage	250V AC
Kutu Adedi Pack. Unit	10
Ağırlık Weight	100 Gr.

Bağlantı Şeması

Wiring Diagram

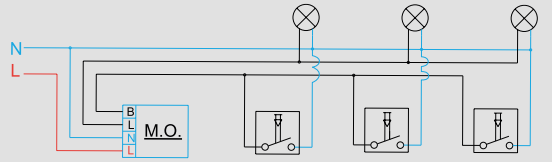

İşıklı Merdiven İşaretli Çağırma

Push Button With Light & Stairway

IP54



Ürün Kodu Cat. No	3201-015-0601
Maksimum Amper Maximum Ampere	10A
Voltaj Voltage	250V AC
Kutu Adedi Pack. Unit	10
Ağırlık Weight	100 Gr.

Bağlantı Şeması

Wiring Diagram

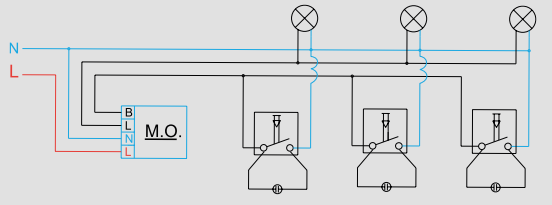

Komütatör Vavien

Two Way Switch Vavien

IP54



Ürün Kodu Cat. No	3201-017-0601
Maksimum Amper Maximum Ampere	10A
Voltaj Voltage	250V AC
Kutu Adedi Pack. Unit	10
Ağırlık Weight	100 Gr.

Bağlantı Şeması

Wiring Diagram

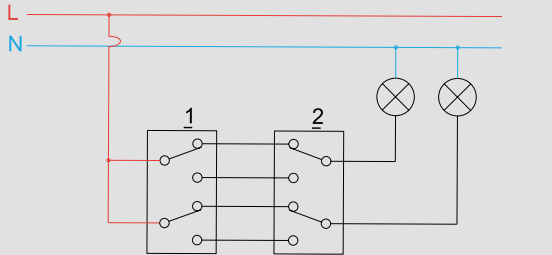

İşıklı Komütatör

Two Way Switch With Light

IP54



Ürün Kodu Cat. No	3201-021-0601
Maksimum Amper Maximum Ampere	10A
Voltaj Voltage	250V AC
Kutu Adedi Pack. Unit	10
Ağırlık Weight	100 Gr.

Bağlantı Şeması

Wiring Diagram

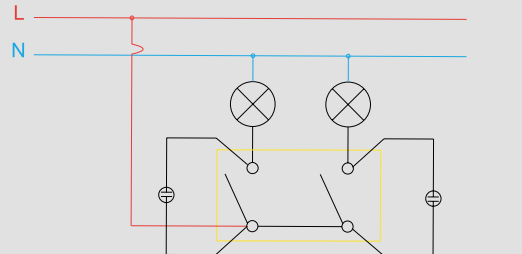

NEMLİYER PRİZLER

WEATHER PROOF SOCKETS

Bağlantı Şeması
Wiring Diagram

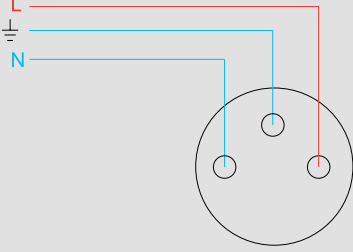

Ürün Kodu Cat. No	3201-025-0601
Norm Version	Alman German (DIN) 
Maksimum Amper Maximum Ampere	16A
Voltaj Voltage	250V AC
Kutu Adedi Pack. Unit	10
Ağırlık Weight	100 Gr.

Priz
Socket

IP54



Bağlantı Şeması
Wiring Diagram

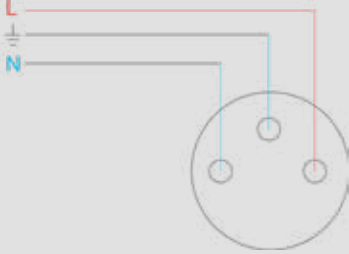

Ürün Kodu Cat. No	3201-033-0601
Norm Version	Fransız French 
Maksimum Amper Maximum Ampere	16A
Voltaj Voltage	250V AC
Kutu Adedi Pack. Unit	10
Ağırlık Weight	100 Gr.

Priz
Socket

IP54



Bağlantı Şeması
Wiring Diagram

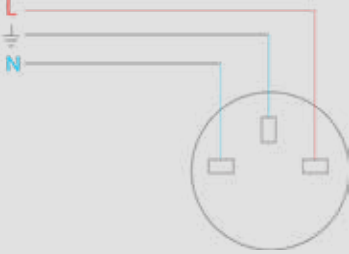

Ürün Kodu Cat. No	3202-025-0600
Norm Version	İngiliz British 
Maksimum Amper Maximum Ampere	13A
Voltaj Voltage	250V AC
Kutu Adedi Pack. Unit	10
Ağırlık Weight	100 Gr.

Priz
Socket

IP54

YENİ ÜRÜN



NEMLİYER PRIZLER

WEATHER PROOF SOCKETS

Telefon Prizi
Telephone Socket (1x4 C RJ11)

IP54



Ürün Kodu Cat. No	3201-041-0600
Kutu Adedi Pack. Unit	10
Ağırlık Weight	102 Gr.

Bağlantı Şeması
Wiring Diagram

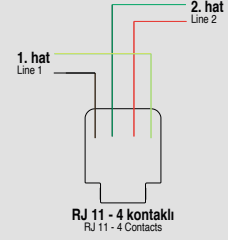

Data Prizi
Data Socket (1xRJ 45 CAT 6)

IP54



Ürün Kodu Cat. No	3201-053-0600
Kutu Adedi Pack. Unit	10
Ağırlık Weight	102 Gr.

Bağlantı Şeması
Wiring Diagram

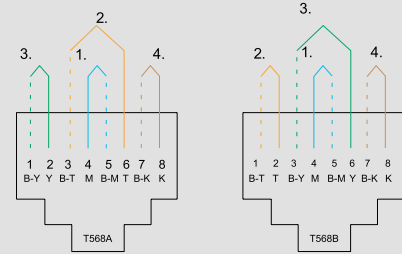

TV Prizi (Sonlu)
TV Socket With Finite

IP54



Ürün Kodu Cat. No	3201-066-0600
Kutu Adedi Pack. Unit	10
Ağırlık Weight	100 Gr.

Bağlantı Şeması
Wiring Diagram

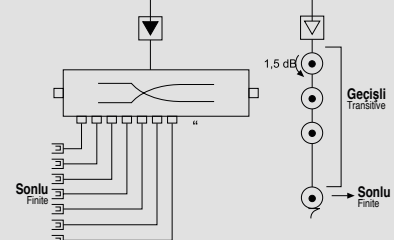

TV Prizi (Geçişli)
TV Socket With Transantative

IP54



Ürün Kodu Cat. No	3201-068-0600
Kutu Adedi Pack. Unit	10
Ağırlık Weight	100 Gr.

Bağlantı Şeması
Wiring Diagram

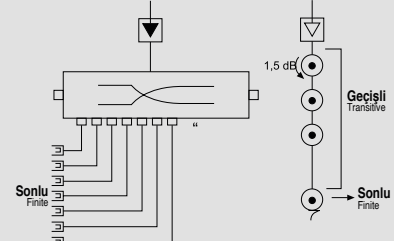

TV Uydu Prizi
TV Satellite Socket

IP54



Ürün Kodu Cat. No	3201-069-0600
Kutu Adedi Pack. Unit	10
Ağırlık Weight	100 Gr.

Bağlantı Şeması
Wiring Diagram

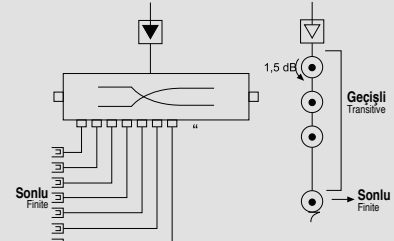

NEMLİYER İKİLİ ÜRÜNLER

WEATHER PROOF SOCKETS

Anahtar + Priz

One Way Switch + Socket

IP54



Ürün Kodu Cat. No	3201-101-0601
Kutu Adedi Pack. Unit	5
Ağırlık Weight	196 Gr.

Komütatör + Priz

Two Way Switch + Socket

IP54



Ürün Kodu Cat. No	3201-102-0601
Kutu Adedi Pack. Unit	5
Ağırlık Weight	196 Gr.

Vavien + Priz

Vavien + Socket

IP54



Ürün Kodu Cat. No	3201-103-0601
Kutu Adedi Pack. Unit	5
Ağırlık Weight	196 Gr.

Çağırma + Priz

Push Button + Socket

IP54



Ürün Kodu Cat. No	3201-104-0601
Kutu Adedi Pack. Unit	5
Ağırlık Weight	196 Gr.

Çift Yollu Anahtar + Priz

Bipolar Switch + Socket

IP54



Ürün Kodu Cat. No	3201-105-0601
Kutu Adedi Pack. Unit	5
Ağırlık Weight	196 Gr.

Priz + Priz

Socket + Socket

IP54



Ürün Kodu Cat. No	3201-125-0601
Kutu Adedi Pack. Unit	5
Ağırlık Weight	196 Gr.

Işıklı Anahtar + Priz

Switch With Light + Socket

IP54



Ürün Kodu Cat. No	3201-108-0601
Kutu Adedi Pack. Unit	5
Ağırlık Weight	196 Gr.

Işıklı Komütatör + Priz

Two Way Switch With Light+ Socket

IP54



Ürün Kodu Cat. No	3201-121-0601
Kutu Adedi Pack. Unit	5
Ağırlık Weight	196 Gr.

Işıklı Çağırma + Priz

Push Button With Light + Socket

IP54



Ürün Kodu Cat. No	3201-110-0601
Kutu Adedi Pack. Unit	5
Ağırlık Weight	196 Gr.

NEMLİYER İKİLİ ÜRÜNLER

WEATHER PROOF SOCKETS

Anahtar + Priz

One Way Switch + Socket

IP54



Ürün Kodu Cat. No	3201-301-0601
Kutu Adedi Pack. Unit	6
Ağırlık Weight	196 Gr.

Komütatör + Priz

Two Way Switch + Socket

IP54



Ürün Kodu Cat. No	3201-302-0601
Kutu Adedi Pack. Unit	6
Ağırlık Weight	196 Gr.

Vavien + Priz

Vavien + Socket

IP54



Ürün Kodu Cat. No	3201-303-0601
Kutu Adedi Pack. Unit	6
Ağırlık Weight	196 Gr.

Çağırma + Priz

Push Button + Socket

IP54



Ürün Kodu Cat. No	3201-304-0601
Kutu Adedi Pack. Unit	6
Ağırlık Weight	196 Gr.

Çift Yollu Anahtar + Priz

Bipolar Switch + Socket

IP54



Ürün Kodu Cat. No	3201-305-0601
Kutu Adedi Pack. Unit	6
Ağırlık Weight	196 Gr.

Priz + Priz

Socket + Socket

IP54



Ürün Kodu Cat. No	3201-325-0601
Kutu Adedi Pack. Unit	6
Ağırlık Weight	196 Gr.

Işıklı Anahtar + Priz

Switch With Light + Socket

IP54



Ürün Kodu Cat. No	3201-308-0601
Kutu Adedi Pack. Unit	6
Ağırlık Weight	196 Gr.

Işıklı Komütatör + Priz

Two Way Switch With Light+ Socket

IP54



Ürün Kodu Cat. No	3201-321-0601
Kutu Adedi Pack. Unit	6
Ağırlık Weight	196 Gr.

Işıklı Çağırma + Priz

Push Button With Light + Socket

IP54



Ürün Kodu Cat. No	3201-310-0601
Kutu Adedi Pack. Unit	6
Ağırlık Weight	196 Gr.

